



SUNNY BOY 3.0 / 3.6 / 4.0 / 5.0 / 6.0

Legal Provisions

The information contained in these documents is the property of SMA Solar Technology AG. No part of this document may be reproduced, stored in a retrieval system, or transmitted, in any form or by any means, be it electronic, mechanical, photographic, magnetic or otherwise, without the prior written permission of SMA Solar Technology AG. Internal reproduction used solely for the purpose of product evaluation or other proper use is allowed and does not require prior approval.

SMA Solar Technology AG makes no representations or warranties, express or implied, with respect to this documentation or any of the equipment and/or software it may describe, including (with no limitation) any implied warranties of utility, merchantability, or fitness for any particular purpose. All such representations or warranties are expressly disclaimed. Neither SMA Solar Technology AG nor its distributors or dealers shall be liable for any indirect, incidental, or consequential damages under any circumstances.

The exclusion of implied warranties may not apply in all cases under some statutes, and thus the above exclusion may not apply.

Specifications are subject to change without notice. Every attempt has been made to make this document complete, accurate and up-to-date. Readers are cautioned, however, that product improvements and field usage experience may cause SMA Solar Technology AG to make changes to these specifications without advance notice or per contract provisions. SMA Solar Technology AG shall not be responsible for any damages, including indirect, incidental or consequential damages, caused by reliance on the material presented, including, but not limited to, omissions, typographical errors, arithmetical errors or listing errors in the content material.

SMA Warranty

You can download the current warranty conditions from the Internet at www.SMA-Solar.com.

Software licenses

The licenses for the installed software modules (open source) can be found in the user interface of the product.

Trademarks

All trademarks are recognized, even if not explicitly identified as such. Missing designations do not mean that a product or brand is not a registered trademark.

SMA Solar Technology AG

Sonnenallee 1

34266 Niestetal

Germany

Tel. +49 561 9522-0

Fax +49 561 9522-100

www.SMA.de

Email: info@SMA.de

Status: 8/24/2021

Copyright © 2019 SMA Solar Technology AG. All rights reserved.

Table of Contents

1	Information on this Document	6
1.1	Validity	6
1.2	Target Group	6
1.3	Content and Structure of this Document	6
1.4	Levels of Warning Messages	6
1.5	Symbols in the Document	7
1.6	Typographical Elements in the Document	7
1.7	Designations in the Document	8
2	Safety	9
2.1	Intended Use	9
2.2	IMPORTANT SAFETY INSTRUCTIONS.....	9
3	Scope of Delivery	14
4	Product Overview	15
4.1	Product Description	15
4.2	Symbols on the Product	16
4.3	Interfaces and Functions	17
4.4	LED Signals	20
4.5	System Overview	22
4.5.1	Circuitry Overview.....	23
4.5.2	Communication Overview	24
5	Mounting.....	25
5.1	Requirements for Mounting	25
5.2	Mounting the Inverter.....	27
6	Electrical Connection	29
6.1	Overview of the Connection Area	29
6.2	AC Connection.....	29
6.2.1	Requirements for the AC Connection	29
6.2.2	Connecting the Inverter to the Utility Grid	31
6.2.3	Connecting Additional Grounding	32
6.3	Connecting the Network Cables.....	33
6.4	Connecting RS485 Devices.....	35
6.5	Mounting the WLAN Antenna	36
6.6	DC Connection.....	36
6.6.1	Requirements for the DC Connection	36
6.6.2	Assembling the DC Connectors	38

6.6.3	Connecting the PV Array.....	40
6.6.4	Disassembling the DC Connectors	42
7	Commissioning	44
7.1	Commissioning Procedure	44
7.2	Commissioning the Inverter.....	45
7.3	Selecting a configuration option	46
7.4	Starting the Self-Test (for Italy and Dubai).....	48
8	Operation	49
8.1	Establishing a connection to the user interface	49
8.1.1	Establishing a Direct Connection via Ethernet	49
8.1.2	Establishing a direct connection via WLAN	49
8.1.3	Establishing a Connection via Ethernet in the local network	51
8.1.4	Establishing a Connection via WLAN in the Local Network	52
8.2	Logging In and Out of the User Interface.....	53
8.3	Start Page Design of the User Interface.....	55
8.4	Activating the Smart Inverter Screen.....	57
8.5	Starting the Installation Assistant.....	58
8.6	Activate WPS Function.....	59
8.7	Switching WLAN On and Off.....	59
8.8	Switching the Dynamic Power Display Off.....	60
8.9	Changing the Password.....	61
8.10	Changing Operating Parameters.....	61
8.11	Configuring the Country Data Set.....	62
8.12	Configuring the Active Power Mode	63
8.13	Configuring the Modbus Function.....	64
8.14	Activating the Receipt of Control Signals (Only for Italy).....	64
8.15	Deactivating Grounding Conductor Monitoring.....	65
8.16	Setting SMA ShadeFix.....	65
8.17	Setting the Rated Residual Current of the Residual-Current Device	66
8.18	Saving the Configuration in a File.....	66
8.19	Adopting a Configuration from a File.....	66
8.20	Updating the Firmware	67
9	Disconnecting the Inverter from Voltage Sources	69
10	Cleaning the Inverter	72
11	Troubleshooting.....	73
11.1	Forgotten Password.....	73
11.2	Event Messages	74

11.3	Checking the PV System for Ground Faults	91
11.4	Problems with streaming services	95
12	Decommissioning the Inverter	96
13	Technical Data	99
13.1	DC/AC	99
13.1.1	Sunny Boy 3.0 / 3.6 / 4.0	99
13.1.2	Sunny Boy 5.0 / 6.0	101
13.2	General Data	103
13.3	Climatic Conditions	104
13.4	Protective Devices	104
13.5	Equipment	105
13.6	Torques	105
13.7	Data Storage Capacity	105
14	Contact	106
15	EU Declaration of Conformity	107

1 Information on this Document

1.1 Validity

This document is valid for:

- SB3.0-1AV-41 (Sunny Boy 3.0) from firmware version \geq 3.00.00.R
- SB3.6-1AV-41 (Sunny Boy 3.6) from firmware version \geq 3.00.00.R
- SB4.0-1AV-41 (Sunny Boy 4.0) from firmware version \geq 3.00.00.R
- SB5.0-1AV-41 (Sunny Boy 5.0) from firmware version \geq 3.00.00.R
- SB6.0-1AV-41 (Sunny Boy 6.0) from firmware version \geq 3.00.00.R

1.2 Target Group

This document is intended for qualified persons and end users. Only qualified persons are allowed to perform the activities marked in this document with a warning symbol and the caption "Qualified person". Tasks that do not require any particular qualification are not marked and can also be performed by end users. Qualified persons must have the following skills:

- Knowledge of how an inverter works and is operated
- Training in how to deal with the dangers and risks associated with installing, repairing and using electrical devices and installations
- Training in the installation and commissioning of electrical devices and installations
- Knowledge of all applicable laws, standards and directives
- Knowledge of and compliance with this document and all safety information

1.3 Content and Structure of this Document

This document describes the mounting, installation, commissioning, configuration, operation, troubleshooting and decommissioning of the product as well as the operation of the product user interface.

You will find the latest version of this document and further information on the product in PDF format and as eManual at www.SMA-Solar.com. You can also call up the eManual via the user interface of the product.

Illustrations in this document are reduced to the essential information and may deviate from the real product.

1.4 Levels of Warning Messages

The following levels of warning messages may occur when handling the product.

DANGER

Indicates a hazardous situation which, if not avoided, will result in death or serious injury.

WARNING

Indicates a hazardous situation which, if not avoided, could result in death or serious injury.



⚠ CAUTION

Indicates a hazardous situation which, if not avoided, could result in minor or moderate injury.

NOTICE

Indicates a situation which, if not avoided, can result in property damage.

1.5 Symbols in the Document

Symbol	Explanation
	Information that is important for a specific topic or goal, but is not safety-relevant
<input type="checkbox"/>	Indicates a requirement for meeting a specific goal
<input checked="" type="checkbox"/>	Desired result
x	A problem that might occur
	Example
▲ QUALIFIED PERSON	Sections describing activities to be performed by qualified persons only

1.6 Typographical Elements in the Document

Typography	Use	Example
bold	<ul style="list-style-type: none"> Messages Terminals Elements on a user interface Elements to be selected Elements to be entered 	<ul style="list-style-type: none"> Connect the insulated conductors to the terminals X703:1 to X703:6. Enter 10 in the field Minutes.
>	<ul style="list-style-type: none"> Connects several elements to be selected 	<ul style="list-style-type: none"> Select Settings > Date.
[Button] [Key]	<ul style="list-style-type: none"> Button or key to be selected or pressed 	<ul style="list-style-type: none"> Select [Enter].
#	<ul style="list-style-type: none"> Placeholder for variable components (e.g., parameter names) 	<ul style="list-style-type: none"> Parameter WCtHz.Hz#

1.7 Designations in the Document

Complete designation	Designation in this document
Sunny Boy	Inverter, product

2 Safety

2.1 Intended Use

The Sunny Boy is a transformerless PV inverter with two MPP trackers which converts the direct current of the PV array to grid-compliant alternating current and feeds it into the utility grid.

The product is suitable for indoor and outdoor use.

The product must only be operated with PV modules of protection class II in accordance with IEC 61730, application class A. The PV modules must be compatible with this product.

The product is not equipped with an integrated transformer and therefore has no galvanic isolation. The product must not be operated with PV modules whose outputs are grounded. This can cause the product to be destroyed. The product may be operated with PV modules whose frame is grounded.

PV modules with a high capacity to ground must only be used if their coupling capacity does not exceed 1.4 μF (for information on how to determine the coupling capacity, see the Technical Information "Leading Leakage Currents" at www.SMA-Solar.com).

All components must remain within their permitted operating ranges and their installation requirements at all times.

The product must only be used in countries for which it is approved or released by SMA Solar Technology AG and the grid operator.

Use SMA products only in accordance with the information provided in the enclosed documentation and with the locally applicable laws, regulations, standards and directives. Any other application may cause personal injury or property damage.

Alterations to the SMA products, e.g., changes or modifications, are only permitted with the express written permission of SMA Solar Technology AG. Unauthorized alterations will void guarantee and warranty claims and in most cases terminate the operating license. SMA Solar Technology AG shall not be held liable for any damage caused by such changes.

Any use of the product other than that described in the Intended Use section does not qualify as the intended use.

The enclosed documentation is an integral part of this product. Keep the documentation in a convenient, dry place for future reference and observe all instructions contained therein.

This document does not replace and is not intended to replace any local, state, provincial, federal or national laws, regulations or codes applicable to the installation, electrical safety and use of the product. SMA Solar Technology AG assumes no responsibility for the compliance or non-compliance with such laws or codes in connection with the installation of the product.

The type label must remain permanently attached to the product.

2.2 IMPORTANT SAFETY INSTRUCTIONS

SAVE THESE INSTRUCTIONS

This section contains safety information that must be observed at all times when working.

The product has been designed and tested in accordance with international safety requirements. As with all electrical or electronic devices, there are residual risks despite careful construction. To prevent personal injury and property damage and to ensure long-term operation of the product, read this section carefully and observe all safety information at all times.

 **DANGER**

Danger to life due to electric shock when live components or DC cables are touched

When exposed to light, the PV modules generate high DC voltage which is present in the DC cables. Touching live DC cables results in death or lethal injuries due to electric shock.

- Do not touch non-insulated parts or cables.
- Disconnect the product from voltage sources and make sure it cannot be reconnected before working on the device.
- Wear suitable personal protective equipment for all work on the product.

 **DANGER**

Danger to life due to electric shock when live components are touched on opening the product

High voltages are present in the live parts and cables inside the product during operation. Touching live parts and cables results in death or lethal injuries due to electric shock.

- Do not open the product.

 **DANGER**

Danger to life due to electric shock from touching an ungrounded PV module or array frame

Touching ungrounded PV modules or array frames results in death or lethal injuries due to electric shock.

- Connect and ground the frame of the PV modules, the array frame and the electrically conductive surfaces so that there is continuous conduction. Observe the applicable local regulations.

⚠ DANGER**Danger to life due to electric shock when touching live system components in case of a ground fault**

If a ground fault occurs, parts of the system may still be live. Touching live parts and cables results in death or lethal injuries due to electric shock.

- Disconnect the product from voltage sources and make sure it cannot be reconnected before working on the device.
- Touch the cables of the PV array on the insulation only.
- Do not touch any parts of the substructure or frame of the PV array.
- Do not connect PV strings with ground faults to the inverter.

⚠ DANGER**Danger to life due to electric shock in case of overvoltages and if surge protection is missing**

Overvoltages (e. g. in the event of a flash of lightning) can be further conducted into the building and to other connected devices in the same network via the network cables or other data cables if there is no surge protection. Touching live parts and cables results in death or lethal injuries due to electric shock.

- Ensure that all devices in the same network are integrated in the existing overvoltage protection.
- When laying the network cable outdoors, ensure that there is suitable surge protection at the network cable transition from the product outdoors to the network inside the building.

⚠ WARNING**Danger to life due to fire or explosion**

In rare cases, an explosive gas mixture can be generated inside the product under fault conditions. In this state, switching operations can cause a fire inside the product or explosion. Death or lethal injuries due to hot or flying debris can result.

- In the event of a fault, do not perform any direct actions on the product.
- Ensure that unauthorized persons have no access to the product.
- Do not operate the DC load-break switch on the inverter in the event of ground fault
- Disconnect the PV array from the inverter via an external disconnection device. If there is no disconnecting device present, wait until no more DC power is applied to the inverter.
- Disconnect the AC circuit breaker, or keep it disconnected in case it has already tripped, and secure it against reconnection.
- Only perform work on the product (e.g., troubleshooting, repair work) when wearing personal protective equipment for handling of hazardous substances (e.g., safety gloves, eye and face protection, respiratory protection).

⚠ WARNING**Risk of injury due to toxic substances, gases and dusts.**

In rare cases, damages to electronic components can result in the formation of toxic substances, gases or dusts inside the product. Touching toxic substances and inhaling toxic gases and dusts can cause skin irritation, burns or poisoning, trouble breathing and nausea.

- Only perform work on the product (e.g., troubleshooting, repair work) when wearing personal protective equipment for handling of hazardous substances (e.g., safety gloves, eye and face protection, respiratory protection).
- Ensure that unauthorized persons have no access to the product.

⚠ WARNING**Danger to life due to electric shock from destruction of the measuring device due to overvoltage**

Overvoltage can damage a measuring device and result in voltage being present in the enclosure of the measuring device. Touching the live enclosure of the measuring device results in death or lethal injuries due to electric shock.

- Only use measuring devices with a DC input voltage range of 600 V or higher.

⚠ CAUTION**Risk of burns due to hot enclosure parts**

Some parts of the enclosure can get hot during operation. Touching hot enclosure parts can result in burn injuries.

- During operation, do not touch any parts other than the enclosure lid of the inverter.

⚠ CAUTION**Risk of injury due to weight of product**

Injuries may result if the product is lifted incorrectly or dropped while being transported or mounted.

- Transport and lift the product carefully. Take the weight of the product into account.
- Wear suitable personal protective equipment for all work on the product.

NOTICE**High costs due to inappropriate Internet tariff**

Depending on use, the data volume of the product transferred via the Internet may vary in size. The data volume depends, for example, on the number of inverters in the system, the frequency of device updates, the frequency of data transfer to Sunny Portal or the use of FTP push. High costs for the Internet connection can be the result.

- SMA Solar Technology AG recommends using an Internet flat rate.

NOTICE**Damage to the product due to cleaning agents**

The use of cleaning agents may cause damage to the product and its components.

- Clean the product and all its components only with a cloth moistened with clear water.

i Change to the names and units of grid parameters to comply with the grid-connection requirements in accordance with Regulation (EU) 2016/631 (valid from April 27, 2019)

To comply with the EU grid-connection requirements (valid from April 27, 2019) the names and units of grid parameters were changed. This change is valid from firmware version $\geq 3.00.00.R$ if a country data set for fulfilling the EU grid-connection requirements (valid from 2019-04-27) is set. Names and units of grid parameters for inverters with firmware version $\leq 2.99.99.R$ are not affected by this change and remain valid. This also applies from firmware version $\geq 3.00.00.R$ if a country data set that is valid for countries outside the EU is set.

3 Scope of Delivery

Check the scope of delivery for completeness and any externally visible damage. Contact your distributor if the scope of delivery is incomplete or damaged.

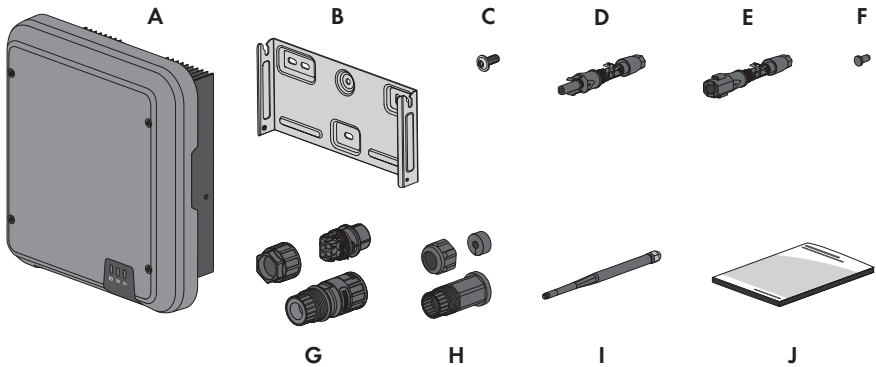

Figure 1: Components included in the scope of delivery

Position	Quantity	Designation
A	1	Inverter
B	1	Wall mounting bracket
C	3	Pan head screw M5x12
D	4	Positive DC connector
E	4	Negative DC connector
F	8	Sealing plug
G	1	AC connector
H	1	RJ45 protective sleeve: swivel nut, cable support sleeve, threaded sleeve
I	1	WLAN antenna
J	1	<p>Quick reference guide with password label on the rear side</p> <p>The label contains the following information:</p> <ul style="list-style-type: none"> • PIC (Product Identification Code) identification key for registering the system in Sunny Portal • RID (Registration Identifier) registration ID for registering the system in Sunny Portal • WLAN password WPA2-PSK (WiFi Protected Access 2 - Preshared Key) for direct connection to the inverter via WLAN

4 Product Overview

4.1 Product Description

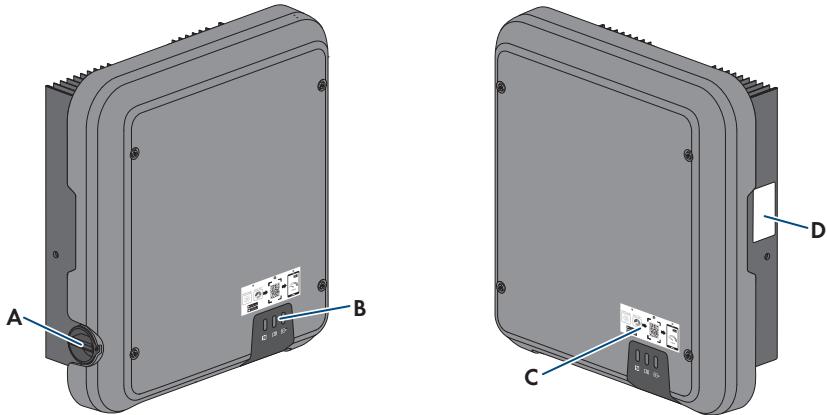





















Figure 2: Design of the product

Position	Designation
A	DC load-break switch
B	LEDs The LEDs indicate the operating state of the product.
C	Label with QR Code for scanning via the SMA 360° App and easy connection to the inverter's user interface via WLAN
D	Type label The type label clearly identifies the product. The type label must remain permanently attached to the product. You will find the following information on the type label: <ul style="list-style-type: none"> • Device type (Model) • Serial number (Serial No. or S/N) • Date of manufacture • Identification key (PIC) for registration in Sunny Portal • Registration ID (RID) for registration in Sunny Portal • WLAN password (WPA2-PSK) for the direct connection to the user interface of the inverter via WLAN • Device-specific characteristics

4.2 Symbols on the Product

Symbol	Explanation
	Beware of a danger zone This symbol indicates that the product must be additionally grounded if additional grounding or equipotential bonding is required at the installation site.
	Beware of electrical voltage The product operates at high voltages.
	Beware of hot surface The product can get hot during operation.
	Danger to life due to high voltages in the inverter; observe a waiting time of 5 minutes High voltages that can cause lethal electric shocks are present in the live components of the inverter. Prior to performing any work on the inverter, disconnect it from all voltage sources as described in this document.
	Observe the documentation Observe all documentation supplied with the product.
	Observe the documentation Together with the red LED, this symbol indicates an error.
	Inverter Together with the green LED, this symbol indicates the operating state of the inverter.
	Data transmission Together with the blue LED, this symbol indicates the status of the network connection.
	Grounding conductor This symbol indicates the position for connecting a grounding conductor.
	Alternating current
	Direct current

Symbol	Explanation
	The product has no galvanic isolation.
	WEEE designation Do not dispose of the product together with the household waste but in accordance with the disposal regulations for electronic waste applicable at the installation site.
	The product is suitable for outdoor installation.
IP65	Degree of protection IP65 The product is protected against the penetration of dust and water that is directed as a jet against the enclosure from all directions.
	CE marking The product complies with the requirements of the applicable EU directives.
	RoHS labeling The product complies with the requirements of the applicable EU directives.
	RCM (Regulatory Compliance Mark) The product complies with the requirements of the applicable Australian standards.
	ICASA The product complies with the requirements of the South African standards for telecommunication.
	ANATEL The product complies with the requirements of the Brazilian standards for telecommunication. Este equipamento opera em caráter secundário, isto é, não tem direito a proteção contra interferência prejudicial, mesmo de estações do mesmo tipo, e não pode causar interferência a sistemas operando em caráter primário.
	The product complies with the Moroccan safety and EMC requirements for electronic products.

4.3 Interfaces and Functions

The product is equipped with the following interfaces and functions:

User interface for monitoring and configuration

The product is equipped as standard with an integrated webserver, which provides a user interface for configuring and monitoring the product. The product user interface can be called up via the web browser if there is an existing connection to an end device (e.g. computer, tablet PC or smartphone).

Smart Inverter Screen

The Smart Inverter Screen enables you to view the status display and to display the current power and consumption on the user interface login page. This gives you an overview of the most important inverter data without having to log into the user interface.

The Smart Inverter Screen is deactivated by default. The Smart Inverter Screen can be activated via the user interface once the inverter has been commissioned.

SMA Speedwire

The product is equipped with SMA Speedwire as standard. SMA Speedwire is a type of communication based on the Ethernet standard. SMA Speedwire is designed for a data transfer rate of 100 Mbps and enables optimum communication between Speedwire devices within systems.

The products supports the encrypted system communication with SMA Speedwire Encrypted Communication. In order to be able to use the Speedwire encryption in the system, all Speedwire devices, except for the SMA Energy Meter, must support the function SMA Speedwire Encrypted Communication.

SMA Webconnect

The product is equipped with a Webconnect function as standard. The Webconnect function enables direct data transmission between the product and Internet portals Sunny Portal and Sunny Places without any additional communication device and for a maximum of 4 products per visualized system. In PV systems with more than 4 products, there is the option of establishing data transmission between the products and Sunny Portal via the data logger (e.g., SMA Data Manager) or distributing the inverters over several systems. If there is an existing WLAN or Ethernet connection, you can directly access your visualized system via the web browser on your end device.

Webconnect enables - for PV systems operated in Italy - the connection or disconnection of the inverter to or from the utility grid and the specifying of the frequency limits to be used via IEC61850-GOOSE messages.

WLAN connection to SMA 360° app

The product has a QR code. By scanning the QR Code attached to the product via the SMA 360° app, access to the product is established via WLAN and the connection to the user interface is made automatically.

WLAN

The product is equipped with a WLAN interface as standard. The inverter is delivered with the WLAN interface activated as standard. If you do not want to use WLAN, you can deactivate the WLAN interface.

In addition, the product has a WPS function. The WPS function is for automatically connecting the product to a network (e.g. via router) and establish a direct connection between the product and an end device.

Modbus

The product is equipped with a Modbus interface. The Modbus interface is deactivated by default and must be configured as needed.

The Modbus interface of the supported SMA products is designed for industrial use – via SCADA systems, for example – and has the following tasks:

- Remote query of measured values
- Remote setting of operating parameters
- Setpoint specifications for system control

RS485 Interface

The inverter is equipped with an RS485 interface as standard. The inverter can communicate via cables with SMA communication products or with up to three gateways for the TS4 module technology via the RS485 interface (information on supported SMA products at www.SMA-Solar.com).

Integration of TS4-R module technology

The inverter is equipped with an RS485 interface and the Cloud Connect function as standard to integrate the TS4 module technology. Up to three gateways in line topology can be connected to the inverter via the RS485 interface. The use of a separate Cloud Connect Advanced communication unit is not required. The Cloud Connect function has the following functions:

- Easy integration of the TS4 module technology components into the system
- Easy commissioning and configuration via the user interface of the inverter
- Visualization and monitoring via Sunny Portal

Grid management services

The product is equipped with service functions for grid management.

Depending on the requirements of the grid operator, you can activate and configure the functions (e.g. active power limitation) via operating parameters.

Parallel Operation of the DC Inputs A and B

You have the option of operating the inverter DC inputs A and B in parallel. As a result, and as opposed to normal operation, several parallel-connected strings can be connected to the inverter. The inverter automatically detects the parallel operation of the DC inputs A and B.

SMA ShadeFix

The inverter is equipped with the shade management system SMA ShadeFix. SMA ShadeFix uses an intelligent MPP tracking system to determine the operating point with the highest output during shading conditions. With SMA ShadeFix, inverters use the best possible energy supply from the PV modules at all times to increase yields in shaded systems. SMA ShadeFix is enabled by default. The time interval of SMA ShadeFix is usually six minutes. This means that the inverter determines the optimum operating point every six minutes. Depending on the PV system or shading situation, it may be useful to adjust the time interval.

All-pole sensitive residual-current monitoring unit

The all-pole sensitive residual-current monitoring unit detects alternating and direct differential currents. In single-phase and three-phase inverters, the integrated differential current sensor detects the current difference between the neutral conductor and the line conductor(s). If the current difference increases suddenly, the inverter disconnects from the utility grid.

SMA Smart Connected

SMA Smart Connected is the free monitoring of the product via the SMA Sunny Portal. Thanks to SMA Smart Connected, the operator and qualified person will be informed automatically and proactively about product events that occur.

SMA Smart Connected is activated during registration in Sunny Portal. In order to use SMA Smart Connected, it is necessary that the product is permanently connected to Sunny Portal and the data of the operator and qualified person is stored in Sunny Portal and up-to-date.

4.4 LED Signals

The LEDs indicate the operating state of the product.

LED signal	Explanation
The green LED is flashing (two seconds on and two seconds off)	Waiting for feed-in conditions The conditions for feed-in operation are not yet met. As soon as the conditions are met, the inverter will start feed-in operation.
The green LED flashes quickly	Update of central processing unit The central processing unit of the inverter is being updated.
The green LED is glowing	Feed-in operation The inverter feeds in with a power of at least 90%.
The green LED is pulsing	Feed-in operation The inverter is equipped with a dynamic power display via the green LED. Depending on the power, the green LED pulses fast or slow. If necessary, you can switch off the dynamic power display via the green LED.
The green LED is off	The inverter is not feeding into the utility grid.

LED signal	Explanation
The red LED is glowing	<p>Event occurred</p> <p>If an event occurs, a distinct event message and the corresponding event number will be displayed in addition on the product user interface or in the communication product (e.g. SMA Data Manager).</p>
The blue LED flashes slowly for approx. one minute	<p>Communication connection is being established</p> <p>The inverter is establishing a connection to a local network or is establishing a direct connection to an end device via Ethernet (e.g. computer, tablet PC or smartphone).</p>
The blue LED flashes quickly for approx. two minutes (0.25 s on and 0.25 s off).	<p>WPS active</p> <p>The WPS function is active.</p>
The blue LED is glowing	<p>Communication active</p> <p>There is an active connection with a local network or there is a direct connection with an end device via Ethernet (e.g. computer, tablet PC or smartphone).</p>

4.5 System Overview

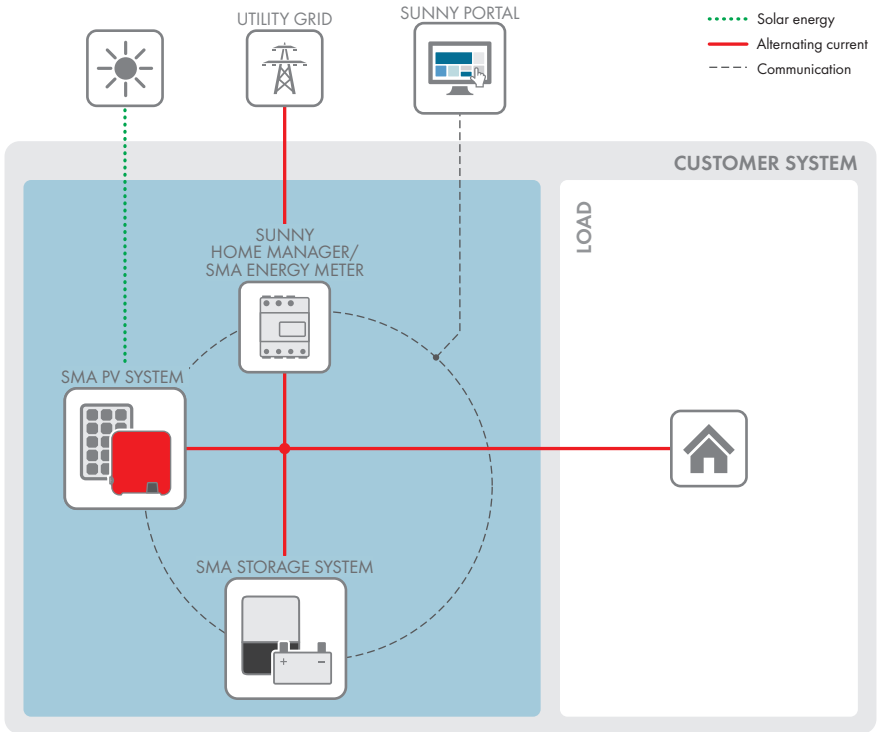

4.5.1 Circuitry Overview

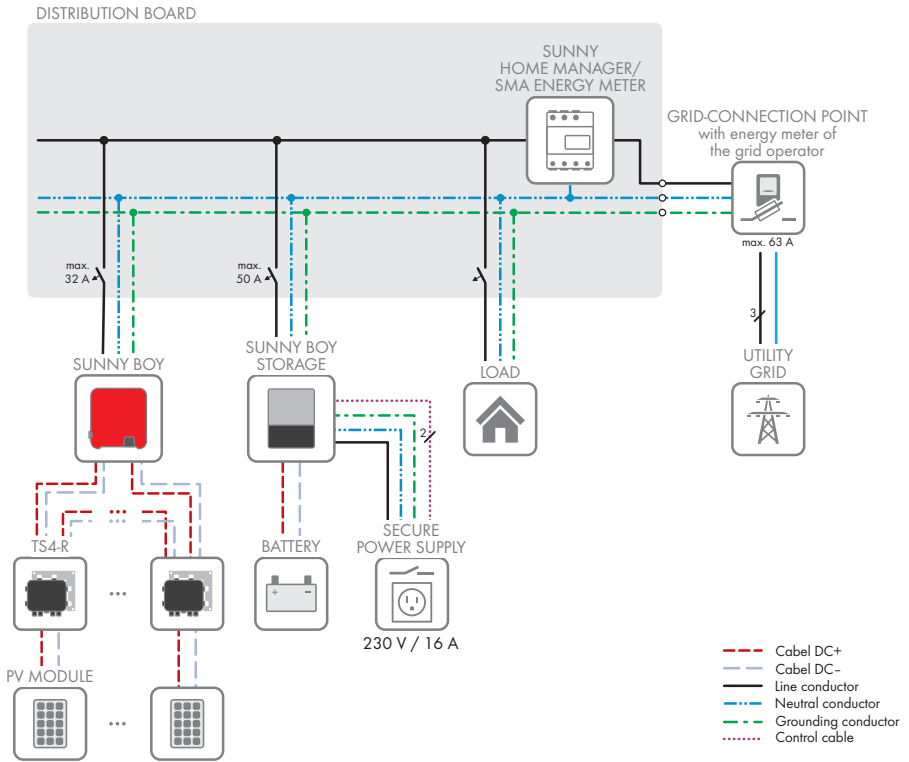

Figure 3: Circuitry overview (example)

4.5.2 Communication Overview

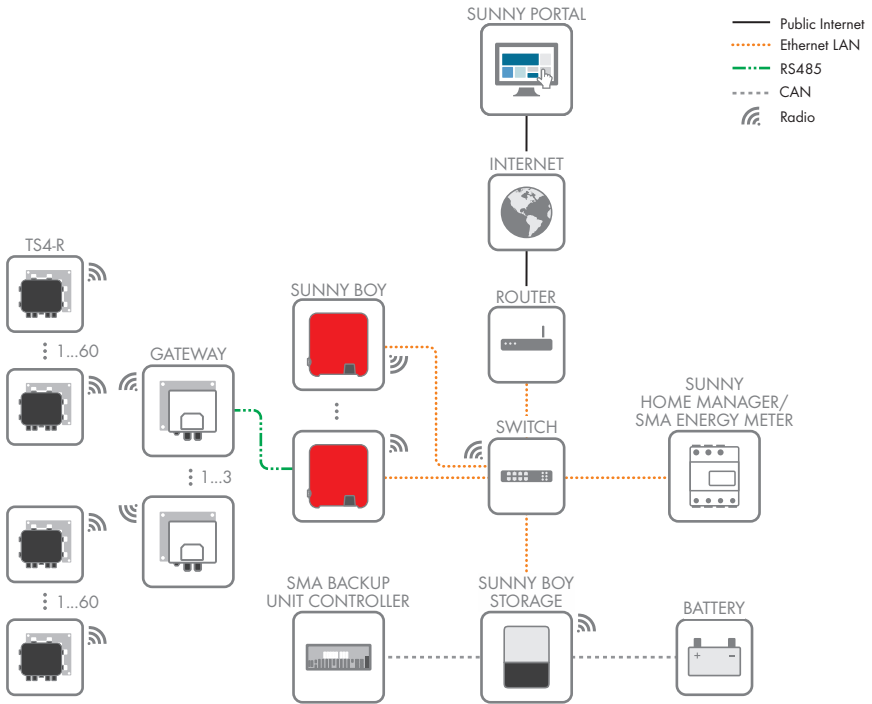

Figure 4: Design of system communication

5 Mounting

5.1 Requirements for Mounting

Requirements for the Mounting Location:

⚠ WARNING

Danger to life due to fire or explosion

Despite careful construction, electrical devices can cause fires. This can result in death or serious injury.

- Do not mount the product in areas containing highly flammable materials or gases.
 - Do not mount the product in potentially explosive atmospheres.
- A solid support surface must be available (e.g., concrete or masonry). When mounted on drywall or similar materials, the product emits audible vibrations during operation which could be perceived as annoying.
 - The mounting location must be inaccessible to children.
 - The mounting location must be suitable for the weight and dimensions of the product (see Section 13 "Technical Data", page 99).
 - The mounting location must not be exposed to direct solar irradiation. If the product is exposed to direct solar irradiation, the exterior plastic parts might age prematurely and overheating might occur. When becoming too hot, the product reduces its power output to avoid overheating.
 - The mounting location should be freely and safely accessible at all times without the need for any auxiliary equipment (such as scaffolding or lifting platforms). Non-fulfillment of these criteria may restrict servicing.
 - The DC load-break switch of the product must always be freely accessible.
 - All ambient conditions must be met (see Section 13, page 99).
 - To ensure optimum operation, the ambient temperature should be between -25°C and $+40^{\circ}\text{C}$.

Permitted and prohibited mounting positions:

- The product may only be mounted in a permitted position. This will ensure that no moisture can penetrate the product.
- The product should be mounted such that the LED signals can be read off without difficulty.

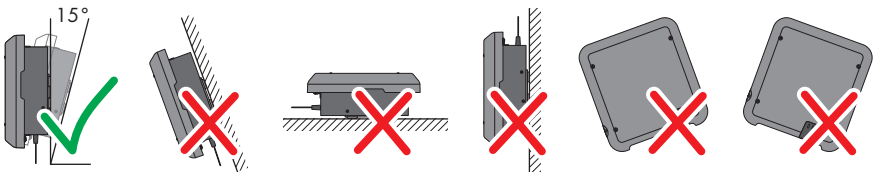

Figure 5: Permitted and prohibited mounting positions

Dimensions for mounting:

Figure 6: Position of the anchoring points(Dimensions in mm)

Recommended clearances:

If you maintain the recommended clearances, adequate heat dissipation will be ensured. Thus, you will prevent power reduction due to excessive temperature.

- Maintain the recommended clearances to walls as well as to other inverters or objects.
- If multiple inverters are mounted in areas with high ambient temperatures, increase the clearances between the inverters and ensure sufficient fresh-air supply.

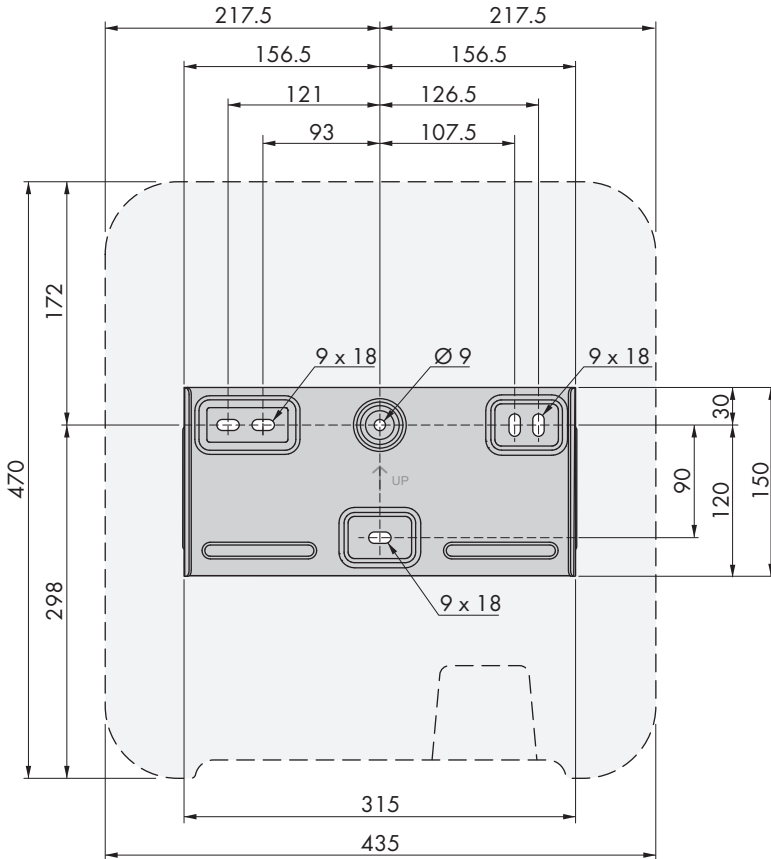
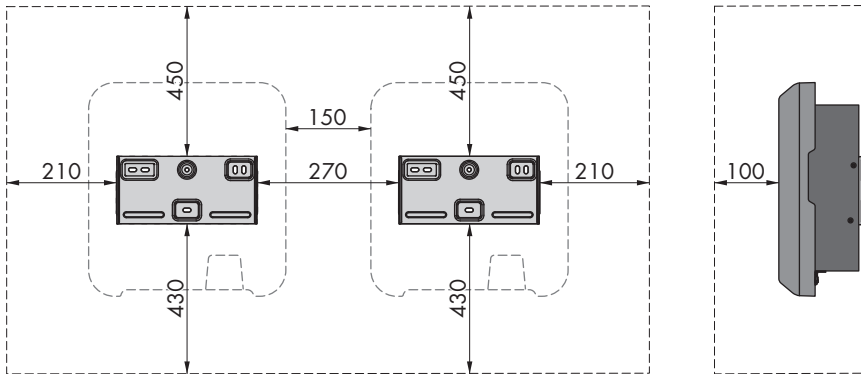

Figure 7: Recommended clearances(Dimensions in mm)

5.2 Mounting the Inverter

Additionally required mounting material (not included in the scope of delivery):

- 3 screws, suitable for the support surface and the weight of the inverter (diameter: minimum 6 mm)
- 3 washers, suitable for the screws (outer diameter: minimum 18 mm)
- Where necessary, three screw anchors suitable for the support surface and the screws

⚠ CAUTION

Risk of injury due to weight of product

Injuries may result if the product is lifted incorrectly or dropped while being transported or mounted.

- Transport and lift the product carefully. Take the weight of the product into account.
- Wear suitable personal protective equipment for all work on the product.

Procedure:

1.

⚠ CAUTION

Risk of injury due to damaged cables

There may be power cables or other supply lines (e.g., gas or water) routed in the wall.

- Ensure that no lines are laid in the wall which could be damaged when drilling holes.

2. Align the wall mounting bracket horizontally on the wall and mark the position of the drill holes. Use at least one hole on the right- and left-hand side and the lower hole in the middle of the wall mounting bracket. Tip: When mounting on a post, use the upper and lower central holes of the wall mounting bracket.

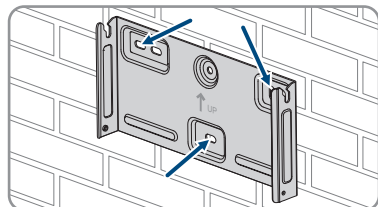

3. Set the wall mounting bracket aside and drill the marked holes.
4. Insert screw anchors into the drill holes if the support surface requires them.
5. Secure the wall mounting bracket horizontally using screws and washers.

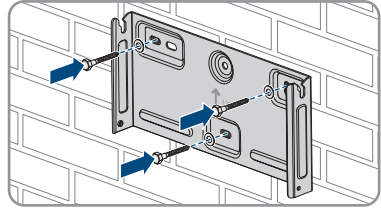

6. Hook the inverter into the wall mounting bracket. When doing so, the two right- and left-hand keys on the ribs on the rear side of the inverter must be hooked into the respective keyways in the wall mounting bracket.

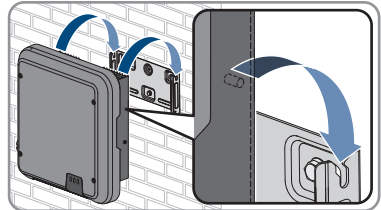

7. Ensure that the inverter is securely in place.
8. Secure the inverter to the wall mounting bracket. To do so, insert one pan head screw M5x12 each into the lower screw hole on both sides of the inverter anchorage bracket respectively and tighten them using a Torx screwdriver (TX 25, torque: 2.5 Nm).

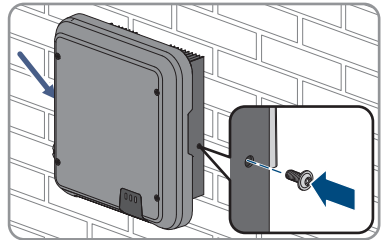

6 Electrical Connection

6.1 Overview of the Connection Area

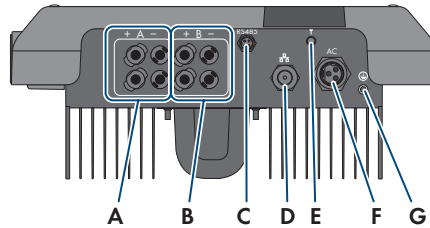

Figure 8: Connection areas at the bottom of the inverter

Position	Designation
A	2 positive and 2 negative DC connectors, input A
B	2 positive and 2 negative DC connectors, input B
C	Jack with protective cap for RS485 communication connection
D	Network port with protective cap
E	Jack with protective cap for the WLAN antenna
F	Jack for the AC connection
G	Connection point for an additional grounding

6.2 AC Connection

6.2.1 Requirements for the AC Connection

AC cable requirements as follows:

- Conductor type: copper wire
- External diameter: 8 mm to 21 mm
- Conductor cross-section: 1.5 mm² to 6 mm²
- Insulation stripping length: 12 mm
- Sheath stripping length: 50 mm
- The cable must be dimensioned in accordance with the local and national directives for the dimensioning of cables. The requirements for the minimum wire size derive from these directives. Examples of factors influencing cable dimensioning are: nominal AC current, type of cable, routing method, cable bundling, ambient temperature and maximum desired line losses (for calculation of line losses, see the design software "Sunny Design" from software version 2.0 at www.SMA-Solar.com).

Grounding cable requirements:**i Use of fine-stranded conductors**

You can use an inflexible or a flexible, fine-stranded conductor.

- When using a fine-stranded conductor, it has to be double crimped by a ring terminal lug. Make sure that no insulated conductor is visible when pulling or bending. This will ensure sufficient strain relief by means of the ring terminal lug.

Grounding cable cross-section: max. 10 mm²

Load-break switch and cable protection:**NOTICE****Damage to the inverter due to the use of screw-type fuses as load-break switches**

Screw-type fuses (e.g. DIAZED fuse or NEOZED fuse) are not load-break switches.

- Do not use screw-type fuses as load-break switches.
- Use a load-break switch or circuit breaker as a load disconnection unit (for information and design examples, see the Technical Information "Circuit Breaker" at www.SMA-Solar.com).

- In PV systems with multiple inverters, protect each inverter with a separate circuit breaker. Make sure to observe the maximum permissible fuse protection (see Section 13 "Technical Data", page 99). This will prevent residual voltage from being present at the corresponding cable after disconnection.
- Loads installed between the inverter and the circuit breaker must be fused separately.

Also see:

> Section 13 "Technical Data", page 99

Residual-current monitoring unit:

The inverter does not require an external residual-current device when operating. If local regulations require the use of a residual-current device, the following must be observed:

- The inverter with firmware version 3.00.10.R is compatible with type A/B residual-current devices that have a rated residual current of 30 mA or higher (information about the selection of a residual-current device see technical information "Criteria for Selecting a Residual-Current Device" at www.SMA-Solar.com). Each inverter in the system must be connected to the utility grid via a separate residual-current device.
- When using residual-current devices with a rated residual current of 30 mA, the rated residual current must be set in the inverter (see Section 8.17, page 66). In this way the inverter reduces the operational leakage currents and prevents a false triggering of the residual-current device.

Overvoltage category:

The inverter can be used in grids of overvoltage category III or lower in accordance with IEC 60664-1. That means that the inverter can be permanently connected to the grid-connection point of a building. In case of installations with long outdoor cabling routes, additional measures to reduce overvoltage category IV to overvoltage category III are required (see the Technical Information "Overvoltage Protection" at www.SMA-Solar.com).

Grounding conductor monitoring:

The inverter is equipped with a grounding conductor monitoring device. This grounding conductor monitoring device detects when there is no grounding conductor connected and disconnects the inverter from the utility grid if this is the case. Depending on the installation site and grid configuration, it may be advisable to disable the grounding conductor monitoring. This can be necessary, for example, in a Delta IT system or other grid configurations if there is no neutral conductor present and you intend to install the inverter between two line conductors. If you are uncertain about this, contact your grid operator or SMA Solar Technology AG.

- Grounding conductor monitoring must be disabled after initial start-up depending on the grid configuration (see Section 8.15, page 65).

i **Safety in accordance with IEC 62109 when the grounding conductor monitoring is deactivated**

In order to guarantee safety in accordance with IEC 62109 when the grounding conductor monitoring is deactivated, you have to connect an additional grounding conductor to the inverter.

- Connect an additional grounding conductor that has a cross-section of at least 10 mm (see Section 6.2.3, page 32). This prevents touch current in the event of the grounding conductor on the AC connector bush insert failing.

i **Connection of an additional grounding conductor**

In some countries, an additional grounding conductor is generally required. In each case, observe the locally applicable regulations.

- If an additional grounding conductor is required, connect the one that has a cross-section of at least 10 mm (see Section 6.2.3, page 32). This prevents touch current in the event of the grounding conductor on the AC connector bush insert failing.

Also see:

- > Section 13 "Technical Data", page 99

6.2.2 Connecting the Inverter to the Utility Grid

Requirements:

- The connection requirements of the grid operator must be met.
- The grid voltage must be within the permissible range. The exact operating range of the inverter is specified in the operating parameters.

Procedure:

1. Disconnect the circuit breaker and secure it against reconnection.
2. Dismantle the AC cable by 50 mm.
3. Shorten L and N by 8 mm each, so that the grounding conductor is 8 mm longer. This ensures that the grounding conductor is the last to be pulled from the screw terminal in the event of tensile strain.
4. Strip the insulation of L, N and the grounding conductor 12 mm.
5. In the case of fine stranded wire L, N and PE are to be fitted with bootlace ferrules.
6. Assemble the AC connector and connect the conductor to the AC connector (see manual of the AC connector).
7. Ensure that all conductors are securely connected to the AC connector.
8. Plug the AC connector into the jack for the AC connection. When doing so, align the AC connector so that the key on the inverter AC jack is inserted into the keyway on the AC connector bush insert.

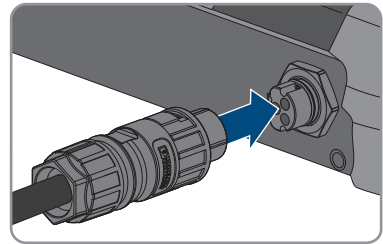

6.2.3 Connecting Additional Grounding

If additional grounding or equipotential bonding is required locally, you can connect additional grounding to the inverter. This prevents touch current if the grounding conductor on the AC connector fails. The necessary ring terminal lug and the screw are included in the scope of delivery of the inverter.

Additionally required material (not included in the scope of delivery):

- 1 grounding cable

Grounding cable requirements:
i Use of fine-stranded conductors

You can use an inflexible or a flexible, fine-stranded conductor.

- When using a fine-stranded conductor, it has to be double crimped by a ring terminal lug. Make sure that no insulated conductor is visible when pulling or bending. This will ensure sufficient strain relief by means of the ring terminal lug.

- Grounding cable cross-section: max. 10 mm²

Procedure:

1. Strip the grounding cable insulation.

2. Insert the stripped part of the grounding cable into the ring terminal lug and crimp using a crimping tool.

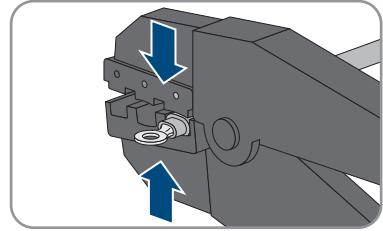

3. Insert the pan head screw M5x12 into the screw hole in the ring terminal lug and screw the ring terminal lug with screw firmly onto the connection point for additional grounding using a Torx screwdriver (TX 25, torque: 2.5 Nm).

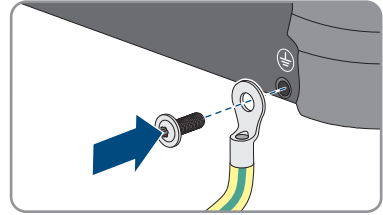

6.3 Connecting the Network Cables

⚠ DANGER

Danger to life due to electric shock in case of overvoltages and if surge protection is missing

Overvoltages (e. g. in the event of a flash of lightning) can be further conducted into the building and to other connected devices in the same network via the network cables or other data cables if there is no surge protection. Touching live parts and cables results in death or lethal injuries due to electric shock.

- Ensure that all devices in the same network are integrated in the existing overvoltage protection.
- When laying the network cable outdoors, ensure that there is suitable surge protection at the network cable transition from the product outdoors to the network inside the building.

NOTICE

Damage to the inverter due to moisture ingress

Moisture penetration can damage the inverter and impair its functionality.

- Connect the network cable with the supplied RJ45 protective sleeve to the inverter.

Additionally required material (not included in the scope of delivery):

- 1 network cable

Network cable requirements:

The cable length and quality affect the quality of the signal. Observe the following cable requirements.

- Cable type: 100BaseTx

- Cable category: minimum CAT5e
- Plug type: RJ45 of Cat5, Cat5e or higher
- Shielding: SF/UTP, S/UTP, SF/FTP or S/FTP
- Number of insulated conductor pairs and insulated conductor cross-section: at least 2 x 2 x 0.22 mm²
- Maximum cable length between two nodes when using patch cables: 50 m (164 ft)
- Maximum cable length between two nodes when using installation cables: 100 m (328 ft)
- UV-resistant for outdoor use.

Procedure:

1.

⚠ DANGER**Danger to life due to electric shock**

- Disconnect the inverter from all voltage sources (see Section 9, page 69).

2. Unscrew the protective cap from the network port.

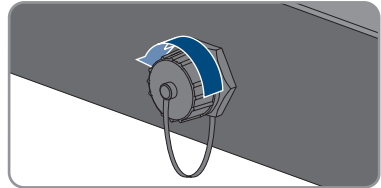

3. Press the cable support sleeve out of the threaded sleeve.

4. Thread the swivel nut and threaded sleeve over the network cable. At the same time, thread the network cable through the opening in the cable support sleeve.

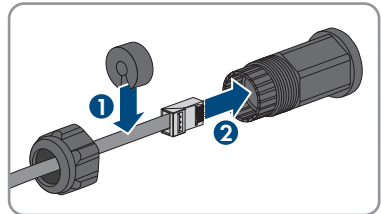

5. Press the cable support sleeve into the threaded sleeve.

6. Plug the network cable connector into the network port on the inverter and screw the threaded sleeve onto the network port thread on the inverter.

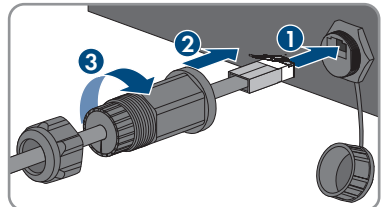

7. Screw the swivel nut onto the threaded sleeve.

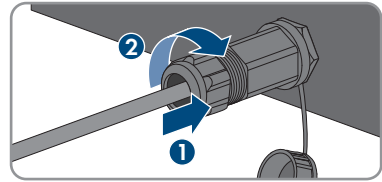

8. If you would like to establish a direct connection, connect the other end of the network cable directly to the end device.

9. If you would like to integrate the inverter into a local network, connect the other end of the network cable to the local network (e.g., via a router).

6.4 Connecting RS485 Devices

Additionally required material (not included in the scope of delivery):

- One communication cable for RS485 communication
- One M12 plug, 4-pole

Signal assignment:

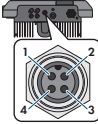
	Pin connector	Signal	TS4 Gateway	Sunny WebBox	Sunny Boy Control	Insulated conductor color
	1	GND	-	5	5	
	2	+12 V	+	-	-	
	3	Data-	B	7	8	
	4	Data+	A	2	3	

Procedure:

1. **DANGER**

Danger to life due to electric shock

- Disconnect the inverter from all voltage sources (see Section 9, page 69).

2. Assemble the M12 plug and connect the RS485 cable to the plug (see manual of the M12 connector).

3. Ensure that all conductors are correctly connected to the M12 plug.

4. Unscrew the protective cap from the jack for the RS485 communication connection.

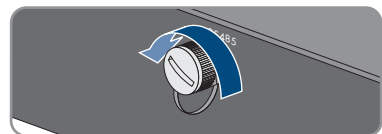

5. Plug the M12 connector into the jack for the RS485 communication connection and screw tight. When doing so, align the connector so that the key on the inverter AC jack is inserted into the keyway on the plug.

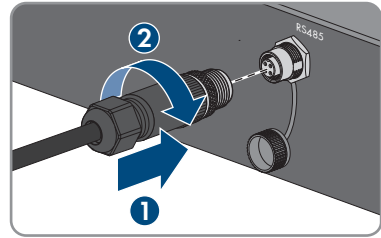

6.5 Mounting the WLAN Antenna

Requirement:

- The WLAN antenna supplied must be used.

Procedure:

1.

⚠ DANGER

Danger to life due to electric shock

- Disconnect the inverter from all voltage sources (see Section 9, page 69).

2. Remove the protective cap from the jack on the inverter.
3. Plug the WLAN antenna into the jack and screw tight (torque: 1 Nm).

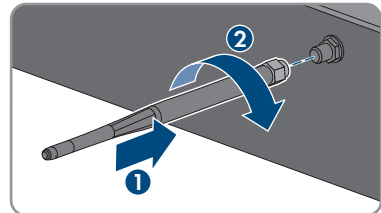

4. Pull on the WLAN antenna to ensure that the WLAN antenna is securely in place.

6.6 DC Connection

6.6.1 Requirements for the DC Connection

Connection options:

The inverter has two DC inputs, to each of which one string can be connected in normal operation.

You have the option of operating the DC inputs A and B in parallel, and therefore of connecting several strings to the inverter.

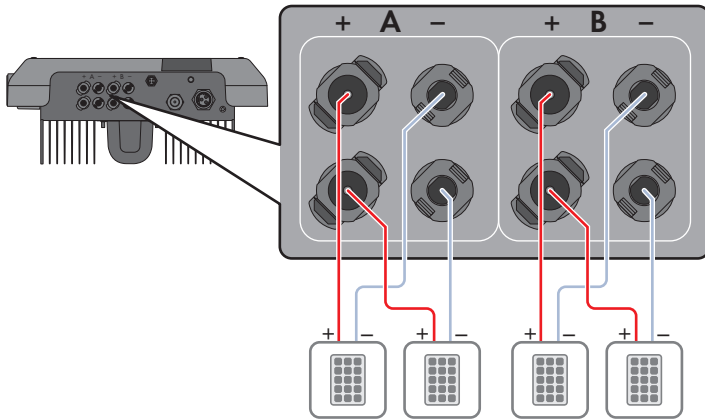

Figure 9: Connection overview for normal operation

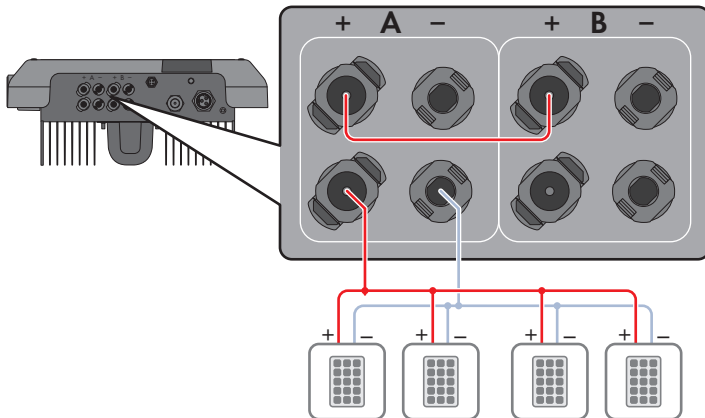

Figure 10: Connection overview for parallel connection of the DC inputs A and B

Requirements for the PV modules per input:

- All PV modules should be of the same type.
- All PV modules should be aligned and tilted identically.
- On the coldest day based on statistical records, the open-circuit voltage of the PV array must never exceed the maximum input voltage of the inverter.
- The same number of series-connected PV modules must be connected to each string.
- The maximum input current per string must be maintained and must not exceed the through-fault current of the DC connectors (see Section 13 "Technical Data", page 99).

- The thresholds for the input voltage and the input current of the inverter must be adhered to (see Section 1.3 "Technical Data", page 99).
- The positive connection cables of the PV modules must be equipped with positive DC connectors (see Section 6.6.2, page 38).
- The negative connection cables of the PV modules must be equipped with the negative DC connectors (see Section 6.6.2, page 38).

i Use of Y adapters for parallel connection of strings

The Y adapters must not be used to interrupt the DC circuit.

- Do not use the Y adapters in the immediate vicinity of the inverter. The adapters must not be visible or freely accessible.
- In order to interrupt the DC circuit, always disconnect the inverter as described in this document (see Section 9, page 69).

6.6.2 Assembling the DC Connectors

⚠ DANGER

Danger to life due to electric shock when live components or DC cables are touched

When exposed to light, the PV modules generate high DC voltage which is present in the DC cables. Touching live DC cables results in death or lethal injuries due to electric shock.

- Do not touch non-insulated parts or cables.
- Disconnect the product from voltage sources and make sure it cannot be reconnected before working on the device.
- Wear suitable personal protective equipment for all work on the product.

NOTICE

Destruction of the inverter due to overvoltage

If the open-circuit voltage of the PV modules exceeds the maximum input voltage of the inverter, the inverter can be destroyed due to overvoltage.

- If the open-circuit voltage of the PV modules exceeds the maximum input voltage of the inverter, do not connect any strings to the inverter and check the design of the PV system.

For connection to the inverter, all PV module connection cables must be fitted with the DC connectors provided. Assemble the DC connectors as described in the following. The procedure is identical for both connectors (+ and -). The graphics for the procedure are shown for only the positive connector as an example. Pay attention to the correct polarity when assembling the DC connectors. The DC connectors are marked with the symbols "+" and "-".

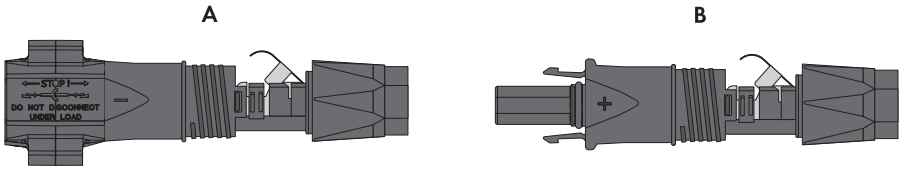

Figure 11: Negative (A) and positive (B) DC connectors

Cable requirements:

- External diameter: 5 mm to 8 mm
- Conductor cross-section: 2.5 mm² to 6 mm²
- Qty single wires: minimum 7
- Nominal voltage: minimum 1000 V
- Using bootlace ferrules is not allowed.

Procedure:

1. Strip 12 mm of the cable insulation.
2. Insert the stripped cable into the DC connector up to the stop. When doing so, ensure that the stripped cable and the DC connector are of the same polarity.
3. Press the clamping bracket down until it audibly snaps into place.

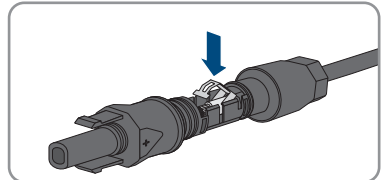
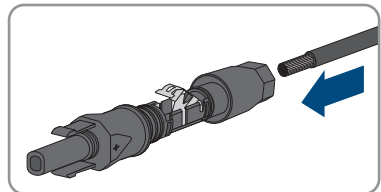

- The stranded wire can be seen inside the clamping bracket chamber.

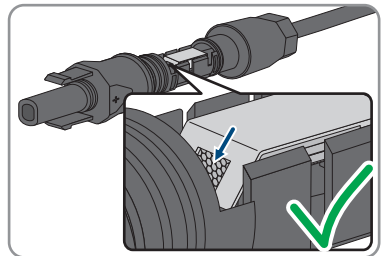

4. If the stranded wire is not visible in the chamber, the cable is not correctly inserted and the connector must be reassembled. To do this, the cable must be removed from the connector.

- Release the clamping bracket. To do so, insert a screwdriver (blade width: 3.5 mm) into the clamping bracket and pry the clamping bracket open.

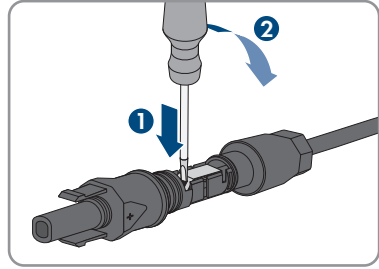

- Remove the cable and go back to step 2.

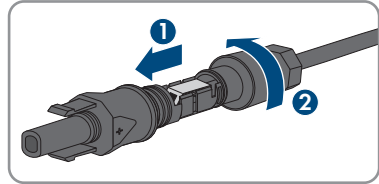

5. Push the swivel nut up to the thread and tighten (torque: 2 Nm).

6.6.3 Connecting the PV Array

NOTICE

Destruction of the inverter due to overvoltage

If the open-circuit voltage of the PV modules exceeds the maximum input voltage of the inverter, the inverter can be destroyed due to overvoltage.

- If the open-circuit voltage of the PV modules exceeds the maximum input voltage of the inverter, do not connect any strings to the inverter and check the design of the PV system.

⚠ WARNING

Danger to life due to electric shock from destruction of the measuring device due to overvoltage

Overvoltage can damage a measuring device and result in voltage being present in the enclosure of the measuring device. Touching the live enclosure of the measuring device results in death or lethal injuries due to electric shock.

- Only use measuring devices with a DC input voltage range of 600 V or higher.

NOTICE

Damage to the DC connectors due to the use of contact cleaner of other cleaning agents

Some contact cleaners or other cleaning agents may contain substances that decompose the plastic of the DC connectors.

- Do not use contact cleaners or other cleaning agents for cleaning the DC connectors.

NOTICE

Damage to the inverter due to ground fault on DC side during operation

Due to the transformerless topology of the product, the occurrence of ground faults on DC side during operation can lead to irreparable damage. Damages to the product due to a faulty or damaged DC installation are not covered by warranty. The product is equipped with a protective device that checks whether a ground fault is present during the starting sequence. The product is not protected during operation.

- Ensure that the DC installation is carried out correctly and no ground fault occurs during operation.

Procedure:

1. Ensure that the circuit breaker is switched off and that it cannot be reconnected.
2. If an external DC load-break switch is installed, disconnect the external DC load-break switch from all voltage sources.
3. Set the DC load-break switch of the inverter to position **O**.

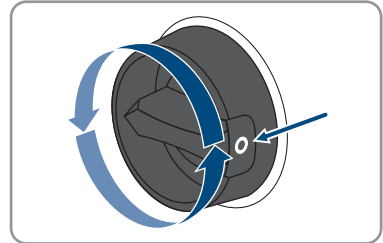

4. Measure the PV array voltage. Ensure that the maximum input voltage of the inverter is adhered to and that there is no ground fault in the PV array.
5. Check whether the DC connectors have the correct polarity.
If the DC connector is equipped with a DC cable of the wrong polarity, the DC connector must be reassembled. The DC cable must always have the same polarity as the DC connector.
6. Ensure that the open-circuit voltage of the PV array does not exceed the maximum input voltage of the inverter.
7. Connect the assembled DC connectors to the inverter.

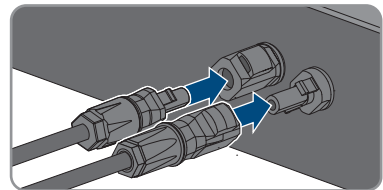

- The DC connectors snap into place.

8. Ensure that all DC connectors are securely in place.

9.

NOTICE**Damage to the product due to sand, dust and moisture ingress if the DC inputs are not closed**

The product is only properly sealed when all unused DC inputs are closed with DC connectors and sealing plugs. Sand, dust and moisture penetration can damage the product and impair its functionality.

- Seal all unused DC inputs using the DC connectors and sealing plugs as described in the following. When doing so, do not plug the sealing plugs directly into the DC inputs on the inverter.

10. For unused DC connectors, push down the clamping bracket and push the swivel nut up to the thread.
11. Insert the sealing plug into the DC connector.

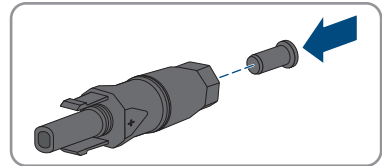

12. Insert the DC connectors with sealing plugs into the corresponding DC inputs on the inverter.
- The DC connectors snap into place.
13. Ensure that the DC connectors with sealing plugs are securely in place.

6.6.4 Disassembling the DC Connectors

To disassemble the DC connectors (e.g. due to faulty assembly), proceed as follows.

⚠ DANGER**Danger to life due to electric shock when touching exposed DC conductors or DC plug contacts if the DC connectors are damaged or loose**

The DC connectors can break or become damaged, become free of the DC cables, or no longer be connected correctly if the DC connectors are released and disconnected incorrectly. This can result in the DC conductors or DC plug contacts being exposed. Touching live DC conductors or DC plug connectors will result in death or serious injury due to electric shock.

- Wear insulated gloves and use insulated tools when working on the DC connectors.
- Ensure that the DC connectors are in perfect condition and that none of the DC conductors or DC plug contacts are exposed.
- Carefully release and remove the DC connectors as described in the following.

Procedure:

1. Release and remove the DC connectors. To do so, insert a flat-blade screwdriver or an angled screwdriver (blade width: 3.5 mm) into one of the side slots and pull the DC connectors out. When doing so, do not lever the DC connectors out, but insert the tool into one of the side slots only to release the locking mechanism, and do not pull on the cable.
2. Remove the DC connector swivel nut.

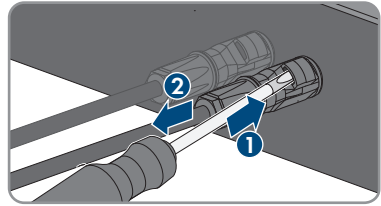

3. Unlock the DC connector. To do this, insert a flat-blade screwdriver (blade width: 3.5 mm) into the side catch mechanism and pry the catch mechanism open.

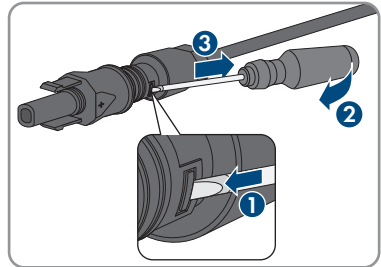
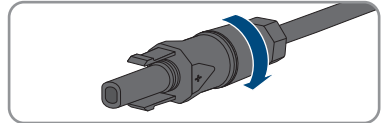

4. Carefully pull the DC connector apart.
5. Release the clamping bracket. To do so, insert a flat-blade screwdriver (blade width: 3.5 mm) into the clamping bracket and pry the clamping bracket open.

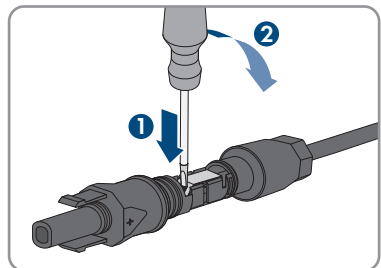

6. Remove the cable.

7 Commissioning

7.1 Commissioning Procedure

i Commissioning a product in SMA Energy Systems

If the product is used in an SMA Energy System, the commissioning must be performed according to the manual of the SMA Energy System. The procedure and the sequence may differ from the steps described in this section.

- Commissioning an SMA Energy System (see system manual of the SMA Energy System).

i Commissioning an inverter that is captured in a communication device

When the inverter is captured in a communication device, the communication device (e.g. SMA Data Manager) is the unit for configuring the total system. The configuration is transferred to all inverters in the system. The system password assigned via the communication device is also the password for the user interface of the inverter.

- Commission the inverter (see Section 7.2, page 45).
- The initial configuration of the inverter is made via the communication device. The configuration is transferred to the inverter and the settings of the inverter are overwritten.
- Deactivate the Webconnect function of the inverter via the Sunny Portal. This prevents unnecessary connection attempts of the inverter with Sunny Portal.

This section describes the commissioning procedure and gives an overview of the steps you must perform in the prescribed order.

Procedure	See
1. Commission the inverter.	Section 7.2, page 45
2. Establish a connection to the user interface of the inverter. There are various connection options to choose from for this: <ul style="list-style-type: none"> • Direct connection via WLAN • Direct connection via Ethernet • Connection via WLAN in the local network • Connection via Ethernet in the local network 	Section 8.1, page 49
3. Log into the user interface.	Section 8.2, page 53
4. Select the inverter configuration option. Please note that the SMA Grid Guard code for changing the grid-relevant parameters must be available after completion of the first ten feed-in hours or installation assistant (see "Application for the SMA Grid Guard code" available at www.SMA-Solar.com).	Section 7.3, page 46
5. Ensure that the country data set has been configured correctly.	Section 8.11, page 62

Procedure	See
6. For PV systems in Italy or Dubai: Start the self-test.	Section 7.4, page 48
7. Make further inverter settings as needed.	Section 8, page 49

7.2 Commissioning the Inverter

Requirements:

- The AC circuit breaker must be correctly rated and mounted.
- The inverter must be correctly mounted.
- All cables must be correctly connected.

Procedure:

1. Switch on the AC circuit breaker.
2. Turn the DC load-break switch of the inverter to position I.

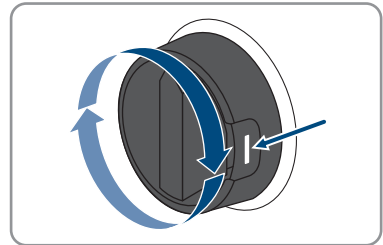

- All three LEDs light up. The start-up phase begins.
 - During start-up phase of the inverter, the desired firmware is being installed.
 - All three LEDs go out again after approximately 90 seconds.
 - The green LED starts to flash and, if the inverter is connected via Speedwire, the blue LED also starts to flash. If the green LED is still flashing after some time, the conditions for activating feed-in operation are not yet met. As soon as the conditions for feed-in operation are met, the inverter starts with feed-in operation and, depending on the available power, the green LED will light up continuously or it will pulse.
3. If the red LED is glowing, an error has occurred that must be rectified (see Section 11, page 73).

7.3 Selecting a configuration option

After having assigned the password to the **Installer** or **User**, the **Configuring the Inverter** page opens.

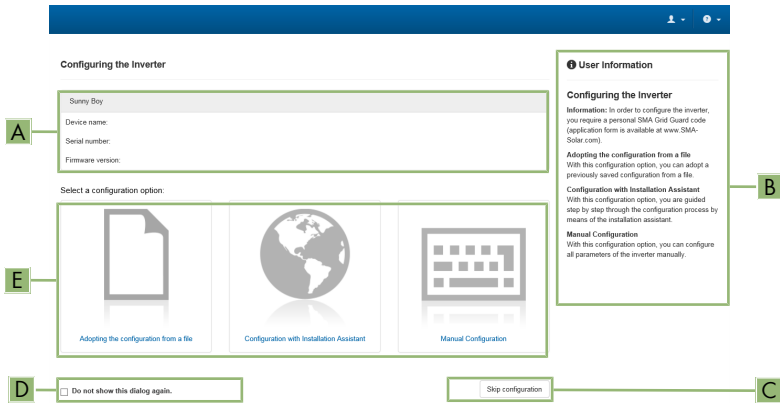

Figure 12: Layout of the **Configuring the Inverter** page

Position	Designation	Description
A	Device information	Provides the following information: <ul style="list-style-type: none"> • Device name • Inverter serial number • Inverter firmware version
B	User information	Provides brief information on the listed configuration options
C	Skip configuration	Offers the option of skipping the inverter configuration and go directly to the user interface (not recommended)
D	Checkbox	Allows you to choose not to have the displayed page displayed again when the user interface is called up again
E	Configuration options	Provides a selection of the various configuration options

Configuration options:

On the **Configuring the Inverter** page, different configuration options are available to choose from. Select one of the options and proceed for the selected option as described below. SMA Solar Technology AG recommends carrying out the configuration with the installation assistant. This way, you ensure that all relevant parameters are set for optimal inverter operation.

- Adoption of configuration from a file

- Configuration with the installation assistant (recommended)
- Manual configuration

i Accepting the settings

Saving the made settings is indicated by an hourglass symbol on the user interface. If the DC voltage is sufficient, the data is transferred directly to the inverter and accepted. If the DC voltage is too low (e. g. in the evening), the settings are saved, but they cannot be directly transferred to or accepted by the inverter. As long as the inverter has not yet received and accepted the settings, the hourglass symbol will continue to be displayed on the user interface. The settings will be accepted when there is sufficient DC voltage applied and the inverter restarts. As soon as the hourglass symbol appears on the user interface, the settings have been saved. The settings will not be lost. You can log off of the user interface and leave the system.

Adopting the Configuration from a File

You can adopt the inverter configuration from a file. To do this, there must be an inverter configuration saved to a file.

Procedure:

1. Select the configuration option **Adopting configuration from a file**.
2. Select [**Browse...**] and select the desired file.
3. Select [**Import file**].

Configuring the Installation Assistant (Recommended)

Procedure:

1. Select the configuration option **Configuration with Installation Assistant**.
 - The installation assistant will open.
2. Follow the installation assistant steps and make the settings appropriate for your system.
3. For every setting made in a step, select [**Save and next**].
 - In the last step, all made settings are listed in a summary.
4. To correct settings you made, select [**Back**], navigate to the desired step, correct settings and select [**Save and continue**].
5. Once all settings are correct, select [**Next**] in the summary.
6. To save the settings to a file, select [**Export a summary**] and save the file on your end device.
7. To export all parameters and their settings, select [**Export all parameters**]. This exports all parameters and their settings into an HTML file.
 - The start page of the user interface opens.

Manual configuration

You can configure the inverter manually by setting the desired parameters.

Procedure:

1. Select the configuration option **Manual Configuration**.
 - The **Device Parameters** menu on the user interface will open and all available parameter groups of the inverter will be displayed.
 2. Select [**Edit parameters**].
 3. Select the desired parameter group.
 - All available parameters of the parameter group will be displayed.
 4. Set the desired parameters.
 5. Select [**Save all**].
- The inverter parameters are set.

7.4 Starting the Self-Test (for Italy and Dubai)

The self-test is only required for inverters that are to be commissioned in Italy or Dubai. The Italian standard CEI 0-21 and the DEWA (Dubai Electricity and Water Authority) stipulate that all inverters that feed into the utility grid are equipped with a self-test function. During the self-test, the inverter will consecutively check the reaction times for overvoltage, undervoltage, maximum frequency and minimum frequency.

The self-test changes the upper and lower disconnection values for each protective function on a linear basis for frequency monitoring and voltage monitoring. As soon as the measured value exceeds the permitted disconnection threshold, the inverter disconnects from the utility grid. In this way, the inverter determines the reaction time and checks itself.

After the self-test has been completed, the inverter automatically switches back to feed-in operation, resets the original disconnection conditions and connects to the utility grid. The test takes approximately three minutes.

Requirements:

- The country data set of the inverter must be set to **CEI 0-21 internal** or **DEWA 2016 internal**.

Procedure:

1. Select the menu **Device Configuration**.
2. Select [**Settings**].
3. Select [**Starting the Self-Test**] in the subsequent context menu.
4. Follow the instructions appearing in the dialog and save the report of the self-test where necessary.

8 Operation

8.1 Establishing a connection to the user interface

8.1.1 Establishing a Direct Connection via Ethernet

Requirements:

- The product must be commissioned.
- An end device (e.g. computer) with an Ethernet interface must be available.
- The product must be connected directly to the end device.
- The respective latest version of one of the following web browsers must be installed: Chrome, Edge, Firefox, Internet Explorer or Safari.
- The SMA Grid Guard code of the Installer must be available for the changing of grid-relevant settings after completion of the first ten feed-in hours or installation assistant (see "Application for SMA Grid Guard Code" at www.SMA-Solar.com).

IP address of the inverter

- Standard inverter IP address for the direct connection via Ethernet: **169.254.12.3**

Procedure:

1. Open the web browser of your end device, enter the IP address **169.254.12.3** in the address bar and press the enter key.
 2.  **Web browser signals a security vulnerability**
After the IP address has been entered, a message might appear indicating that the connection to the user interface of the product is not secure. SMA Solar Technology AG guarantees the security of the user interface.
 - Continue loading the user interface.
- The login page of the user interface opens.

8.1.2 Establishing a direct connection via WLAN

Requirements:

- The product must be commissioned.
- An end device (e.g. computer, tablet PC or smartphone) must be available.
- The respective latest version of one of the following web browsers must be installed: Chrome, Edge, Firefox, Internet Explorer or Safari.
- JavaScript must be enabled in the web browser of the end device.
- The SMA Grid Guard code of the Installer must be available for the changing of grid-relevant settings after completion of the first ten feed-in hours or installation assistant (see "Application for SMA Grid Guard Code" at www.SMA-Solar.com).

i SSID, IP address and WLAN password

- SSID in WLAN: **SMA[serial number]** (e.g. SMA0123456789)
- Device-specific WLAN password: see WPA2-PSK on the type label of the product or the rear side of the manual included in delivery
- Standard access address for a direct connection via WLAN outside of a local network: **http://smalogin.net** or **192.168.12.3**

i Importing and exporting files with end devices having an iOS operating system is not possible.

For technical reasons, importing and exporting files (e.g., importing an inverter configuration, saving the current inverter configuration or exporting events and parameters) is not possible with mobile end devices having an iOS operating system.

- Use an end device that does not have an iOS operating system for importing and exporting files.

You have several options to connect the product to an end device. The procedure can be different depending on the end devices. If the procedures described do not apply to your end device, establish the direct connection via WLAN as described in the manual of your end device.

The following connection options are available:

- Connection to SMA 360° App
- Connection with WPS
- Connection with WLAN network search

Connection to SMA 360° App

Requirements:

- An end device with camera must be available.
- The SMA 360° App must be installed on the end device.
- An user account for Sunny Portal must already exist.

Procedure:

1. Open the SMA 360° App and login with dem Sunny Portal account details.
2. Select **Service > QR-Code Scan**.
3. Scan the QR Code on your product via the SMA 360° App.
 - The end device automatically connects to the inverter. The web browser of your end device opens and the login page of the user interface is displayed.
4. If the web browser of your end device does not open automatically and the login page of the user interface is not displayed, open the web browser and enter **https://smalogin.net** in the address bar.

Connection with WPS

Requirement:

- The end device must have a WPS function.

Procedure:

1. Enable the WPS function on the inverter. To do this, tap on the enclosure lid of the inverter twice.
 - The blue LED flashes quickly for approx. two minutes. The WPS function is active during this time.
2. Enable the WPS function on your end device.
 - The end device automatically connects to the inverter. The web browser of your end device opens and the login page of the user interface is displayed.
3. If the web browser of your end device does not open automatically and the login page of the user interface is not displayed, open the web browser and enter **https://smalogin.net** in the address bar.

Connection with WLAN network search

1. Search for WLAN networks with your end device.
2. Select the SSID of the inverter **SMA[serial number]** in the list with the found WLAN networks.
3. Enter the device-specific WLAN password (see WPA2-PSK on the type label of the product or the rear side of the manual included in delivery).
4. Open the web browser of your end device and enter **https://smalogin.net** in the address bar.
 - The login page of the user interface is displayed.
5. If the login page of the user interface does not open, enter the IP address **192.168.12.3** or, if your end device supports mDNS services, **SMA[serial number].local** or **http://SMA[serial number]** in the address bar of the web browser.

8.1.3 Establishing a Connection via Ethernet in the local network**i New IP address for connecting with a local network**

If the product is connected to a local network (e.g. via a router), the product will receive a new IP address. Depending on the type of configuration, the new IP address will be assigned automatically by the DHCP server (router) or manually by you. Upon completion of the configuration, the product can only be reached via the following access addresses:

- Generally applicable access address: IP address manually assigned or assigned by the DHCP server (router) (identification via network scanner software or network configuration of the router).
- Access address for Apple and Linux systems: **SMA[serial number].local** (e.g. SMA0123456789.local)
- Access address for Windows and Android systems: **http://SMA[serial number]** (e.g., http://SMA0123456789)

Requirements:

- The product must be connected to the local network via a network cable (e.g. via a router).

- The product must be integrated into the local network. Tip: There are various methods of integrating the product into the local network with the aid of the installation assistant.
- An end device (e.g. computer, tablet PC or smartphone) must be available.
- The end device must be in the same local network as the product.
- The respective latest version of one of the following web browsers must be installed: Chrome, Edge, Firefox, Internet Explorer or Safari.
- The SMA Grid Guard code of the Installer must be available for the changing of grid-relevant settings after completion of the first ten feed-in hours or installation assistant (see "Application for SMA Grid Guard Code" at www.SMA-Solar.com).

Procedure:

1. Open the web browser of your end device, enter the IP address of the inverter in the address bar of the web browser and press the enter key.
 2.  **Web browser signals a security vulnerability**
After the IP address has been entered, a message might appear indicating that the connection to the user interface of the product is not secure. SMA Solar Technology AG guarantees the security of the user interface.
 - Continue loading the user interface.
- The login page of the user interface opens.

8.1.4 Establishing a Connection via WLAN in the Local Network** New IP address for connecting with a local network**

If the product is connected to a local network (e.g. via a router), the product will receive a new IP address. Depending on the type of configuration, the new IP address will be assigned automatically by the DHCP server (router) or manually by you. Upon completion of the configuration, the product can only be reached via the following access addresses:

- Generally applicable access address: IP address manually assigned or assigned by the DHCP server (router) (identification via network scanner software or network configuration of the router).
- Access address for Apple and Linux systems: **SMA[serial number].local** (e.g. SMA0123456789.local)
- Access address for Windows and Android systems: **http://SMA[serial number]** (e.g., <http://SMA0123456789>)

Requirements:

- The product must be commissioned.
- The product must be integrated into the local network. Tip: There are various methods of integrating the product into the local network with the aid of the installation assistant.
- An end device (e.g. computer, tablet PC or smartphone) must be available.
- The end device must be in the same local network as the product.
- The respective latest version of one of the following web browsers must be installed: Chrome, Edge, Firefox, Internet Explorer or Safari.

- The SMA Grid Guard code of the Installer must be available for the changing of grid-relevant settings after completion of the first ten feed-in hours or installation assistant (see "Application for SMA Grid Guard Code" at www.SMA-Solar.com).

i **Importing and exporting files with end devices having an iOS operating system is not possible.**

For technical reasons, importing and exporting files (e.g., importing an inverter configuration, saving the current inverter configuration or exporting events and parameters) is not possible with mobile end devices having an iOS operating system.

- Use an end device that does not have an iOS operating system for importing and exporting files.

Procedure:

- Enter the IP address of the inverter in the address bar of the web browser.
 - The login page of the user interface opens.

8.2 Logging In and Out of the User Interface

After a connection to the user interface of the inverter has been established, the login page opens. Log onto the user interface as described below.

i **Usage of cookies**

For the correct display of the user interface, cookies are required. The cookies are used for convenience only. By using this user interface you agree to the placement of cookies.

Log in as Installer or User for the First Time

i **Password assignment for user and installer**

The passwords for the user groups **Installer** and **User** must be assigned when accessing the user interface for the first time. If the inverter was registered in a communication device (e.g., SMA Data Manager) and the system password was assigned, the system password is also the installer password. In this case, only the user password must be assigned.

- If you as a specialist assign the user password, only pass the password on to persons to access the inverter data via the user interface.
- If you as a user assign the installer password, only pass the password on to persons to receive access to the system.

i **Installer password for inverters registered in a communication device or in Sunny Portal**

To be able to register the inverter in a communication device (e.g., SMA Data Manager) or in a Sunny Portal system, the password for the user group **Installer** must match the system password. If you assign a password for the user group **Installer** via the user interface of the inverter, the same password must also be used as the system password.

- Assign a uniform installer password to all SMA devices in the system.

Procedure:

1. In the drop-down list **Language**, select the desired language.

2. In the **Password** field, enter a password for the **User** user group.
 3. In the **Repeat password** field, enter the password again.
 4. Click on **Save**.
 5. In the **New password** field, enter a password for the **Installer** user group. Assign a uniform password to all SMA devices to be registered in a system. The installer password is also the system password.
 6. In the **Repeat password** field, enter the password again.
 7. Click on **Save and log in**.
- The **Configuring the Inverter** page opens.

Log in as the User or Installer

1. In the drop-down list **Language**, select the desired language.
 2. In the **User group** drop-down list, select the entry **Installer** or **User**.
 3. Enter the password in the field **Password**.
 4. Select **Login**.
- The start page of the user interface opens.

Log Out as the User or Installer

1. On the right-hand side of the menu bar, select the menu **User Settings**.
 2. In the subsequent context menu, select [**Logout**].
- The login page of the user interface opens. The logout was successful.

8.3 Start Page Design of the User Interface



Figure 13: Design of the user interface's start page (example)

Position	Designation	Description
A	Menu	<p>Provides the following functions:</p> <ul style="list-style-type: none"> • Home Opens the user interface homepage • Instantaneous values Current measured values of the inverter • Device Parameters The various operating parameters of the inverter can be viewed and configured here depending on the user group. • Events All events that have occurred in the selected time period are displayed here. The event types are Information, Warning and Error. Currently existing events of the types Error and Warning will be additionally displayed in the Device status viewlet. However, only the higher-priority event is displayed. If, for example, there is a Warning and an Error present at the same time, only the Error will be displayed. • Device configuration Various settings for the inverter can be made here. The selection available is dependent on which user group you are logged in as and the operating system of the device with which the user interface has been called up. • Data You will find all data that is saved in the internal memory of the inverter or on an external storage medium on this page.
B	User settings	<p>Provides the following functions, depending on the user group logged in:</p> <ul style="list-style-type: none"> • Starting the installation assistant • SMA Grid Guard login • Logout
C	Help	<p>Provides the following functions:</p> <ul style="list-style-type: none"> • Displaying information on Open Source licenses used • Link to the website of SMA Solar Technology AG

Position	Designation	Description
D	Status bar	<p>Displays the following information:</p> <ul style="list-style-type: none"> • Inverter serial number • Inverter firmware version • IP address of the inverter within the local network and/or IP address of the inverter during WLAN connection • With WLAN connection: Signal strength of WLAN connection • User group logged in • Date and device time of the inverter
E	Current power and current consumption	<p>Temporal progression of the PV power and the power consumption of the household over the selected time period. Please note, the power consumption will only be displayed if an energy meter is installed in the PV system.</p>
F	Status display	<p>The various areas display information on the current status of the PV system.</p> <ul style="list-style-type: none"> • Device status Displays whether the inverter is currently in a fault-free operating state or whether there is an Error or Warning present. • Current power Displays the power currently being generated by the inverter. • Modular technology status Displays how many module technology components are available and the status of each one (only present if the TS4 module technology is connected). • Yield Displays the energy yield of the inverter. • Grid supply Displays the energy supply from the utility grid. • Power at the grid connection point Indicates which power is currently fed in or obtained at the grid-connection point.

8.4 Activating the Smart Inverter Screen

With the Smart Inverter Screen, the most important inverter data is displayed directly on the user interface login page. To activate the Smart Inverter Screen, proceed as listed in the following.

Procedure:

1. Activate the user interface (see Section 8.1, page 49).
 2. Log in as **Installer** or **User**.
 3. Select the menu **User Settings** (see Section 8.3, page 55) on the start page of the user interface.
 4. Select [**Smart Inverter Screen**].
- The Smart Inverter Screen has been activated.

8.5 Starting the Installation Assistant

The installation assistant leads you step-by-step through the steps necessary for the initial configuration of the inverter.

Layout of the installation assistant

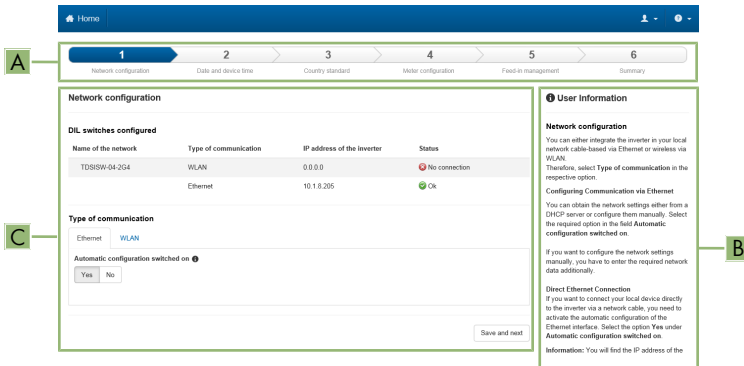

Figure 14: Layout of the installation assistant (example)

Position	Designation	Description
A	Configuration steps	Overview of the installation assistant steps. The number of steps depends on the type of device and the additionally installed modules. The current step is highlighted in blue.
B	User information	Information about the current configuration step and the setting options of the configuration step.
C	Configuration field	You can make settings in this field.

Requirement:

- When configuring after completion of the first ten feed-in hours or after exiting the installation assistant, the SMA Grid Guard code must be available in order to change the grid-relevant parameters (see "Application for SMA Grid Guard Code" at www.SMA-Solar.com).

Procedure:

1. Open the user interface (see Section 8.1, page 49).
 2. Log in as **Installer**.
 3. Select the menu **User Settings** (see Section 8.3, page 55) on the start page of the user interface.
 4. In the context menu, select [**Starting the installation assistant**].
- The installation assistant will open.

8.6 Activate WPS Function

The WPS function can be used for different purposes:

- Automatic connection to a network (e.g. via router)
- Direct connection between the product and an end device

Depending on the intended application of the WPS function, the procedure for activation will vary.

Activating WPS function for automatic connection to a network

Requirements:

- WLAN must be activated in the product.
- WPS must be activated on the router.

Procedure:

1. Activate the user interface (see Section 8.1, page 49).
 2. Log in as **Installer**.
 3. Start the installation assistant (see Section 8.5, page 58).
 4. Select **Network configuration**.
 5. Select **WPS for WLAN network** button in the **WLAN** tab.
 6. Select **Activate WPS**.
 7. Select **Save and next** and exit the installation assistant.
- The WPS function is activated and the automatic connection to the network can be established.

Activating the WPS function for direct connection to the end device.

- Activate the WPS function on the inverter. To do this, tap on the enclosure lid of the inverter twice.
 - The blue LED flashes quickly for approx. two minutes. The WPS function is active during this time.

8.7 Switching WLAN On and Off

The inverter is equipped with an activated WLAN interface as standard. If you do not want to use WLAN, you can switch the WLAN function off and switch it on again whenever needed. In doing so, you can switch the WLAN direct connection and the WLAN connection in the local network on independently of each other.

i Switching on the WLAN function only possible via Ethernet connection

If you switch off both the WLAN function for the direct connection and for the connection in the local network, access to the inverter user interface and therefore reactivation of the WLAN interface is only possible via an Ethernet connection.

The basic procedure for changing operating parameters is explained in another section (see Section 8.10 "Changing Operating Parameters", page 61).

Switching WLAN Off

If you would like to switch the WLAN function off completely, you must switch off both the direct connection and the connection in the local network.

Procedure:

- To switch off the direct connection in the parameter group **PV system communication > WLAN**, select the parameter **Soft-access-point is turned on** and set this to **No**.
- To switch off the connection in the local network in the parameter group **PV system communication > WLAN**, select the parameter **WLAN is turned on** and set this to **No**.

Switching WLAN On

If you have switched the WLAN function for direct connection or for connection in the local network off, you can switch the WLAN function back on in accordance with the following procedure.

Requirement:

- If the WLAN function was previously switched off completely, the inverter must be connected to a computer or router via Ethernet.

Procedure:

- To switch on the WLAN direct connection, in the parameter group **PV system communication > WLAN**, select the parameter **Soft-access-point is turned on** and set this to **Yes**.
- To switch on the WLAN connection in the local network, in the parameter group **System communication > WLAN**, select the parameter **WLAN is turned on** and set this to **Yes**.

8.8 Switching the Dynamic Power Display Off

As standard, the inverter signals its power dynamically via the pulsing of the green LED. When doing so, the LED flashes on and off uniformly or is permanently lit at full power. The various gradations are related here to the set active power limit of the inverter. If this display is not desired, switch this function off in accordance with the following procedure. Once this has been done, the green LED is lit permanently to signalize feed-in operation.

The basic procedure for changing operating parameters is explained in another section (see Section 8.10 "Changing Operating Parameters", page 61).

Procedure:

- In the parameter group **Device > Operation**, select the parameter **Dynamic power display via green LED** and set this to **Off**.

8.9 Changing the Password

The password for the inverter can be changed for both user groups. Furthermore, the user group **Installer** can change the password for the user group **User** as well as its own password.

i PV systems registered in a communication product

With PV systems that are registered in a communication product (e.g. Sunny Portal, Sunny Home Manager), you can also assign a new password for the user group **Installer** via the communication product. The password for the user group **Installer** is also the system password. If you assign a password for the user group **Installer** via the user interface of the inverter that does not correspond to the system password in the communication product, the inverter can no longer be reached by the communication product.

- Ensure that the password for the user group **Installer** is the same as the system password in the communication product.

Procedure:

1. Activate the user interface (see Section 8.1, page 49).
2. Log into the user interface (see Section 8.2, page 53).
3. Call up the menu **Device Parameters**.
4. Select [**Edit parameters**].
5. In the parameter group **User Rights > Access Control** change the password of the desired user group.
6. Select [**Save all**] to save the changes.

8.10 Changing Operating Parameters

The operating parameters of the inverter are set to certain values by default. You can change the operating parameters to optimize the performance of the inverter.

This section describes the basic procedure for changing operating parameters. Always change operating parameters as described in this section. Some function-sensitive parameters can only be viewed by qualified persons and can only be changed by qualified persons by entering the personal SMA Grid Guard code.

i No configuration via Sunny Explorer

Sunny Explorer does not support the configuration of inverters with their own user interface. The inverter can be detected via Sunny Explorer, however it is expressly not recommended to use Sunny Explorer to configure this inverter. SMA Solar Technology AG does not accept liability for missing or incorrect data and possibly resulting yield losses.

- Use the user interface for the configuration of the inverter.

Requirements:

- Changes to grid-relevant parameters must be approved by the responsible grid operator.

Procedure:

1. Open the user interface (see Section 8.1, page 49).
2. Log into the user interface (see Section 8.2, page 53).

3. Call up the menu **Device Parameters**.
 4. Click on [**Edit parameters**].
 5. Log in using the SMA Grid Guard code to change those parameters designated by a lock (only for installers):
 - Select the menu **User Settings** (see Section 8.3, page 55).
 - In the subsequent context menu, select [**SMA Grid Guard login**].
 - Enter the SMA Grid Guard code and select [**Login**].
 6. Expand the parameter group that contains the parameter which is to be configured.
 7. Change the desired parameters.
 8. Select [**Save all**] to save the changes.
- The inverter parameters are set.

i Accepting the settings

Saving the made settings is indicated by an hourglass symbol on the user interface. If the DC voltage is sufficient, the data is transferred directly to the inverter and accepted. If the DC voltage is too low (e. g. in the evening), the settings are saved, but they cannot be directly transferred to or accepted by the inverter. As long as the inverter has not yet received and accepted the settings, the hourglass symbol will continue to be displayed on the user interface. The settings will be accepted when there is sufficient DC voltage applied and the inverter restarts. As soon as the hourglass symbol appears on the user interface, the settings have been saved. The settings will not be lost. You can log off of the user interface and leave the system.

8.11 Configuring the Country Data Set

By default, the inverter is set to a universally valid country data set. You must adjust the country data set for the installation site.

i The country data set must be set correctly.

If you select a country data set which is not valid for your country and purpose, it can cause a disturbance in the PV system and lead to problems with the grid operator. When selecting the country data set, you must always observe the locally applicable standards and directives as well as the properties of the PV system (e.g. PV system size, grid-connection point).

- If you are not sure which standards and directives are valid for your country or purpose, contact the grid operator.

i Change to the names and units of grid parameters to comply with the grid-connection requirements in accordance with Regulation (EU) 2016/631 (valid from April 27, 2019)

To comply with the EU grid-connection requirements (valid from April 27, 2019) the names and units of grid parameters were changed. This change is valid from firmware version $\geq 3.00.00.R$ if a country data set for fulfilling the EU grid-connection requirements (valid from 2019-04-27) is set. Names and units of grid parameters for inverters with firmware version $\leq 2.99.99.R$ are not affected by this change and remain valid. This also applies from firmware version $\geq 3.00.00.R$ if a country data set that is valid for countries outside the EU is set.

The basic procedure for changing operating parameters is explained in another section (see Section 8.10 "Changing Operating Parameters", page 61).

Procedure:

- In the parameter group **Grid monitoring > Grid monitoring** select the parameter **Set country standard** and set the required country data set.

8.12 Configuring the Active Power Mode

Starting the installation assistant

1. Open the user interface (see Section 8.1, page 49).
2. Log in as **Installer**.
3. Start the installation assistant (see Section 8.5, page 58).
4. Select [**Save and continue**] after each step up until the step **Grid management service**.
5. Make the settings as described in the following.

Setting the connected line conductors

- In the tab **Active power mode**, select the line conductor to which the inverter is connected from the drop-down list **Connected line conductors**.

Make the settings for systems with external setpoint

1. Set the **Grid connection point regulation** to [**Off**].
2. In the tab **Active power mode** set the switch **Active power setpoint** to [**On**].
3. In the drop-down list **Operating mode active power setpoint**, select the entry **External setpoint**.
4. In the drop-down list **Fallback behavior**, select the entry **Apply fallback values**.
5. In the field **Fallback value of the maximum active power** enter the value to which the inverter is to limit its nominal power in case of a communication failure to the higher control unit at the end of the timeout time.
6. In the field **Timeout**, enter the time that the inverter is to wait before it limits its nominal power to the set fallback value.
7. If, in the event of a 0% or 0 W specification, the inverter is not permitted to feed small amounts of active power into the utility grid, select the entry **Yes** in the drop-down list **Grid disconnection for 0% active power setpoint**. This ensures that in the event of a 0% or 0 W specification, the inverter disconnects from the utility grid and does not feed in active power.

Make the settings for systems with manual setpoint

1. In the tab **Active power mode** set the switch **Grid connection point regulation** to [**On**].
2. Enter the total PV array power in the field **Nominal PV system power**.
3. In the drop-down list **Operating mode active power setting**, select whether active power limitation is to be performed via a fixed specification in percent or in watts.
4. In the field **Set active power limit**, enter the value to which the active power at the grid-connection point is to be limited. The value must be set to **0** for zero power output.
5. Set the **Active power setpoint** to [**On**].

6. Select the entry **Manual setpoint in %** or **Manual setpoint in W** for manual specification and enter the respective setpoint value.
7. If the inverter itself is to control active power at the grid-connection point, perform the following steps:
 - In the drop-down list **Operating mode active power setting**, select the entry **External setting**.
 - In the drop-down list **Fallback behavior**, select the entry **Apply fallback values**.
 - In the drop-down list **Grid disconnection for 0% active power setting** select the entry **No**.

8.13 Configuring the Modbus Function

The Modbus interface is deactivated by default and the communication ports 502 set.

In order to access SMA inverters with SMA Modbus® or SunSpec® Modbus®, the Modbus interface must be activated. After activating the interface, the communication ports of both IP protocols can be changed. For information on commissioning and configuration of the Modbus interface, see the technical information "SMA and SunSpec Modbus® Interface" at www.SMA-Solar.com.

For information on which Modbus registers are supported, see the technical information "Modbus® parameters and measured values" at www.SMA-Solar.com.

Data security during enabled Modbus interface

If you enable the Modbus interface, there is a risk that unauthorized users may access and manipulate the data or devices in your PV system.

To ensure data security, take appropriate protective measures such as:

- Set up a firewall.
- Close unnecessary network ports.
- Only enable remote access via VPN tunnel.
- Do not set up port forwarding at the communication port in use.
- In order to disable the Modbus interface, reset the inverter to the default settings or disable the parameter again.

Procedure:

- Activate the Modbus interface and adjust the communication ports if necessary (see the technical information "SMA and SunSpec Modbus® Interface" at www.SMA-Solar.com).

8.14 Activating the Receipt of Control Signals (Only for Italy)

In order for PV systems in Italy to receive control commands from the grid operator, set the following parameters.

The basic procedure for changing operating parameters is explained in another section (see Section 8.10 "Changing Operating Parameters", page 61).

Parameter	Value/range	Resolution	Default
Application ID	0 to 16384	1	16384
GOOSE-Mac address	01:0C:CD:01:00:00 to 01:0C:CD:01:02:00	1	01:0C:CD:01:00:00

Procedure:

1. Select the parameter group **External communication > IEC 61850 configuration**.
 2. In the field **Application ID**, enter the application ID of the grid operator gateway. You will receive this value from your grid operator. You can enter a value between 0 and 16384. The value 16384 indicates "deactivated".
 3. In the field **GOOSE-Mac address**, enter the MAC address of the grid operator gateway from which the inverter is to receive the control commands. You will receive this value from your grid operator.
- The receipt of control signals from the grid operator is activated.

8.15 Deactivating Grounding Conductor Monitoring

If the inverter is to be installed in an IT network or another grid configuration in which deactivation of the grounding conductor monitoring is required, deactivate the grounding conductor monitoring as follows.

The basic procedure for changing operating parameters is explained in another section (see Section 8.10 "Changing Operating Parameters", page 61).

Procedure:

- In the parameter group **Grid monitoring > Grid monitoring > Country standard** set the parameter **PE connection monitoring** to **Off**.

8.16 Setting SMA ShadeFix

You can set the time interval in which the inverter has to determine the optimum operating point. If you do not want to use SMA ShadeFix, you can disable the feature.

The basic procedure for changing operating parameters is explained in another section (see Section 8.10 "Changing Operating Parameters", page 61).

Procedure:

- In the parameter group **DC-side > DC settings > SMA ShadeFix**, set the parameter **Time interval of SMA ShadeFix** and set the required time interval. The ideal time interval is usually six minutes. This value should only be increased if the shading situation changes extremely slowly.
 - The inverter optimizes the MPP of the PV system at the predetermined time interval.
- In order to disable the SMA ShadeFix feature, in the parameter group **DC-side > DC settings > SMA ShadeFix**, set the parameter **SMA ShadeFix switched on** to **Off**.

8.17 Setting the Rated Residual Current of the Residual-Current Device

When using residual-current devices with a rated residual current of 30 mA, set the rated residual current to 30 mA. In this way the inverter reduces the operational leakage currents and prevents a false triggering of the residual-current device (for further information, see technical information "Leading Leakage Currents" at www.SMA-Solar.com).

The basic procedure for changing operating parameters is explained in another section (see Section 8.10 "Changing Operating Parameters", page 61).

Procedure:

- Select the parameter **RCD adjustment** and set it to **30 mA**.

Also see:

> Section 8.10 "Changing Operating Parameters", page 61

8.18 Saving the Configuration in a File

You can save the current configuration of the inverter in a file. You can use this file as a data backup for this inverter and then import this file into this inverter again or another inverter from the same type or device family to configure the inverter. When saving, only the device parameters will be saved, not any passwords.

Procedure:

1. Activate the user interface (see Section 8.1, page 49).
2. Log into the user interface (see Section 8.2, page 53).
3. Select the menu **Device Configuration**.
4. Select [**Settings**].
5. In the context menu, select [**Saving the configuration in a file**].
6. Follow the instructions in the dialog.

8.19 Adopting a Configuration from a File

To configure the inverter, you can adopt the configuration from a file. To be able to do this, you must first save the configuration of another inverter from the same type or device family in a file (see Section 8.18 "Saving the Configuration in a File", page 66). When saving, only the device parameters will be adopted, not any passwords.

Requirements:

- Changes to grid-relevant parameters must be approved by the responsible grid operator.
- The SMA Grid Guard code must be available (see "Application for SMA Grid Guard Code" at www.SMA-Solar.com).

Procedure:

1. Open the user interface (see Section 8.1, page 49).

2. Log into the user interface as an **Installer** (see Section 8.2, page 53).
3. Select the menu **Device Configuration**.
4. Select [**Settings**].
5. In the context menu, select [**Adopting the configuration from a file**].
6. Follow the instructions in the dialog.

8.20 Updating the Firmware

If no automatic update is set in the communication product (e.g. SMA Data Manager or Sunny Home Manager) or in Sunny Portal, you have the option of carrying out a manual firmware update.

You have the following options to update the firmware:

- Update the firmware with the existing update file via the user interface of the inverter.
- Search and install the firmware via the user interface of the inverter.

Update the firmware with the existing update file via the user interface of the inverter.

Requirements:

- An update file with the desired inverter firmware must be available. The update file is, for example, available for download on the product page of the inverter at www.SMA-Solar.com. To download the update file, it is necessary to enter the serial number of the inverter.

Procedure:

1. Open the user interface (see Section 8.1, page 49).
2. Log into the user interface as an **Installer** (see Section 8.2, page 53).
3. Select the menu **Device Configuration**.
4. In the inverter row, click on the gear icon and select **Update firmware**.
5. Select [**Browse**] and select the update file for the inverter.
6. Select **Update firmware**.
7. Follow the instructions in the dialog.

Search and install the firmware via the user interface of the inverter.

Requirements:

- The inverter must be connected to the Internet.

Procedure:

1. Open the user interface (see Section 8.1, page 49).
2. Log into the user interface as an **Installer** (see Section 8.2, page 53).
3. Click on [**Edit parameters**].
4. Go to **Device > Update**.

5. Select the parameter **Check for update and install it** and set it to **Execute**.
 6. Click on [**Save all**].
- The firmware is updated in the background.

9 Disconnecting the Inverter from Voltage Sources

Prior to performing any work on the inverter, always disconnect it from all voltage sources as described in this section. Always adhere to the prescribed sequence.

WARNING

Danger to life due to electric shock from destruction of the measuring device due to overvoltage

Overvoltage can damage a measuring device and result in voltage being present in the enclosure of the measuring device. Touching the live enclosure of the measuring device results in death or lethal injuries due to electric shock.

- Only use measuring devices with a DC input voltage range of 600 V or higher.

Procedure:

1. Disconnect the AC circuit breaker and secure it against reconnection.
2. Set the DC load-break switch of the inverter to **O**.

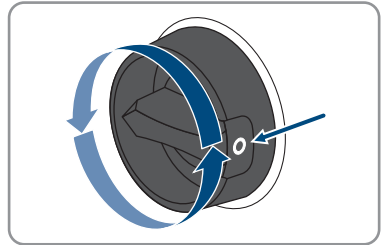

3. Wait until the LEDs have gone out.
4. Use a current clamp to ensure that no current is present in the DC cables.

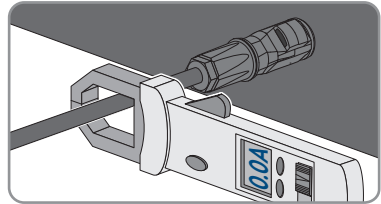

5.

⚠ DANGER**Danger to life due to electric shock when touching exposed DC conductors or DC plug contacts if the DC connectors are damaged or loose**

The DC connectors can break or become damaged, become free of the DC cables, or no longer be connected correctly if the DC connectors are released and disconnected incorrectly. This can result in the DC conductors or DC plug contacts being exposed. Touching live DC conductors or DC plug connectors will result in death or serious injury due to electric shock.

- Wear insulated gloves and use insulated tools when working on the DC connectors.
- Ensure that the DC connectors are in perfect condition and that none of the DC conductors or DC plug contacts are exposed.
- Carefully release and remove the DC connectors as described in the following.

6. Release and remove the DC connectors. To do so, insert a flat-blade screwdriver or an angled screwdriver (blade width: 3.5 mm) into one of the side slots and pull the DC connectors out. When doing so, do not lever the DC connectors out, but insert the tool into one of the side slots only to release the locking mechanism, and do not pull on the cable.

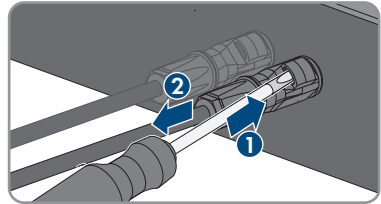

7. Ensure that no voltage is present between the positive terminal and negative terminal at the DC inputs using a suitable measuring device.

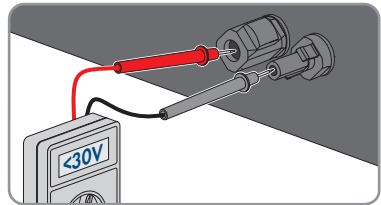

8. Ensure that no voltage is present between the positive terminal and ground as well as between the negative terminal and ground on the DC inputs using a suitable measuring device.

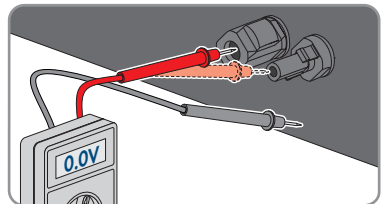

9. Unscrew the AC connector and pull it out of the jack for the AC connection.

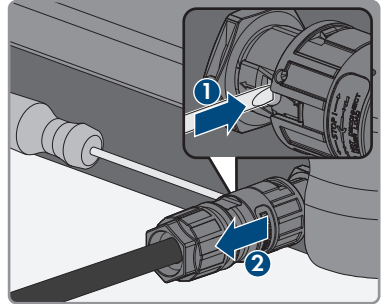

10 Cleaning the Inverter

NOTICE

Damage due to cleaning agents

The use of cleaning agents may cause damage to the product and its components.

- Clean the product and all its components only with a cloth moistened with clear water.
- Ensure that the inverter is free of dust, foliage and other dirt.

11 Troubleshooting

11.1 Forgotten Password

If you have forgotten the password for the inverter, you can unlock the inverter with a Personal Unlocking Key (PUK). For each inverter, there is one PUK for each user group (**User** and **Installer**).
Tipp: With PV systems that are registered in a communication product, you can also assign a new password for the user group **Installer** via the communication product. The password for the user group **Installer** is the same as the system password in the communication product.

Procedure:

1. Request PUK (application form available at www.SMA-Solar.com).
2. Open the user interface (see Section 8.1, page 49).
3. Enter the PUK instead of the password into the field **Password**.
4. Select **Login**.
5. Call up the menu **Device Parameters**.
6. Click on [**Edit parameters**].
7. In the parameter group **User Rights > Access Control** change the password of the desired user group.
8. Select [**Save all**] to save the changes.

i Password assignment for inverters that are registered in a communication product

The password for the user group **Installer** is also the system password for the system in the communication product. Changing the password of the user group **Installer** can lead to the inverter no longer being able to be reached by the communication product.

- In the communication product, assign the changed password of the user group **Installer** as the new system password (see the manual of the communication product).

11.2 Event Messages

Event number	Message, cause and corrective measures
101 102 103 105	<p>⚠ QUALIFIED PERSON</p> <p>Grid fault</p> <p>The grid voltage or grid impedance at the connection point of the inverter is too high. The inverter has disconnected from the utility grid.</p> <p>Corrective measures:</p> <ul style="list-style-type: none"> • Check whether the grid voltage at the connection point of the inverter is permanently in the permissible range. <p>If the grid voltage is outside the permissible range due to local grid conditions, contact the grid operator. The grid operator must agree with an adjustment of the voltage at the feed-in point or with a change of the monitored operating limits.</p> <p>If the grid voltage is permanently within the permissible range and this message is still displayed, contact Service.</p>
202 203 205 206	<p>⚠ QUALIFIED PERSON</p> <p>Grid fault</p> <p>The utility grid has been disconnected, the AC cable is damaged or the grid voltage at the connection point of the inverter is too low. The inverter has disconnected from the utility grid.</p> <p>Corrective measures:</p> <ul style="list-style-type: none"> • Ensure that the circuit breaker is switched on. • Ensure that the AC cable is not damaged and that it is connected correctly. • Ensure that the country data set has been configured correctly. • Check whether the grid voltage at the connection point of the inverter is permanently in the permissible range. <p>If the grid voltage is outside the permissible range due to local grid conditions, contact the grid operator. The grid operator must agree with an adjustment of the voltage at the feed-in point or with a change of the monitored operating limits.</p> <p>If the grid voltage is permanently within the permissible range and this message is still displayed, contact the Service.</p>

Event number	Message, cause and corrective measures
301	<p data-bbox="311 188 595 220">⚠ QUALIFIED PERSON</p> <p data-bbox="288 236 392 260">Grid fault</p> <p data-bbox="288 272 994 384">The ten-minute average value of the grid voltage is no longer within the permissible range. The grid voltage or grid impedance at the connection point is too high. The inverter disconnects from the utility grid to maintain power quality.</p> <p data-bbox="288 395 508 419">Corrective measures:</p> <ul data-bbox="311 427 994 667" style="list-style-type: none"> <li data-bbox="311 427 994 603">• During the feed-in operation, check whether the grid voltage at the connection point of the inverter is permanently in the permissible range. If the grid voltage is outside the permissible range due to local grid conditions, contact the grid operator. The grid operator must agree with an adjustment of the voltage at the feed-in point or with a change of the monitored operating limits. If the grid voltage is permanently within the permissible range and this message is still displayed, contact Service.
302	<p data-bbox="311 683 595 715">⚠ QUALIFIED PERSON</p> <p data-bbox="288 730 622 754">Active power limited AC voltage</p> <p data-bbox="288 767 974 823">The inverter has reduced its power due to a too-high grid voltage to ensure grid stability.</p> <p data-bbox="288 834 508 858">Corrective measures:</p> <ul data-bbox="311 866 1005 1007" style="list-style-type: none"> <li data-bbox="311 866 1005 1007">• If possible, check the grid voltage and observe how often fluctuations occur. If fluctuations occur frequently and this message is displayed often, contact the grid operator and request approval to change the operating parameters of the inverter. If the grid operator gives his approval, discuss any changes to the operating parameters with the Service.
401 404	<p data-bbox="311 1026 595 1058">⚠ QUALIFIED PERSON</p> <p data-bbox="288 1074 392 1098">Grid fault</p> <p data-bbox="288 1110 1005 1166">The inverter has disconnected from the utility grid. A stand-alone grid or a very large change in the power frequency was detected.</p> <p data-bbox="288 1177 508 1201">Corrective measures:</p> <ul data-bbox="311 1209 1005 1235" style="list-style-type: none"> <li data-bbox="311 1209 1005 1235">• Check the grid connection for significant short-term frequency fluctuations.

Event number	Message, cause and corrective measures
501	<p data-bbox="311 183 599 220">⚠ QUALIFIED PERSON</p> <p data-bbox="288 231 392 263">Grid fault</p> <p data-bbox="288 271 991 327">The power frequency is not within the permissible range. The inverter has disconnected from the utility grid.</p> <p data-bbox="288 335 509 359">Corrective measures:</p> <ul data-bbox="311 367 907 422" style="list-style-type: none"> <li data-bbox="311 367 907 422">• If possible, check the power frequency and observe how often fluctuations occur. <p data-bbox="333 430 996 518">If fluctuations occur frequently and this message is displayed often, contact the grid operator and request approval to change the operating parameters of the inverter.</p> <p data-bbox="333 526 940 582">If the grid operator gives his approval, discuss any changes to the operating parameters with the Service.</p>
601	<p data-bbox="311 590 599 627">⚠ QUALIFIED PERSON</p> <p data-bbox="288 638 392 670">Grid fault</p> <p data-bbox="288 678 980 734">The inverter has detected an excessively high proportion of direct current in the grid current.</p> <p data-bbox="288 742 509 766">Corrective measures:</p> <ul data-bbox="311 774 968 861" style="list-style-type: none"> <li data-bbox="311 774 739 805">• Check the grid connection for direct current. <li data-bbox="311 805 968 861">• If this message is displayed frequently, contact the grid operator and check whether the monitoring threshold on the inverter can be raised.
701	<p data-bbox="311 877 599 914">⚠ QUALIFIED PERSON</p> <p data-bbox="288 925 677 957">Frq. not permitted > Check parameter</p> <p data-bbox="288 965 991 1021">The power frequency is not within the permissible range. The inverter has disconnected from the utility grid.</p> <p data-bbox="288 1029 509 1053">Corrective measures:</p> <ul data-bbox="311 1061 907 1117" style="list-style-type: none"> <li data-bbox="311 1061 907 1117">• If possible, check the power frequency and observe how often fluctuations occur. <p data-bbox="333 1125 996 1212">If fluctuations occur frequently and this message is displayed often, contact the grid operator and request approval to change the operating parameters of the inverter.</p> <p data-bbox="333 1220 940 1276">If the grid operator gives his approval, discuss any changes to the operating parameters with the Service.</p>

Event number	Message, cause and corrective measures
901	<p>⚠ QUALIFIED PERSON</p> <p>PE conn. missing > Check connection The grounding conductor is not correctly connected.</p> <p>Corrective measures:</p> <ul style="list-style-type: none"> • Ensure that the grounding conductor is correctly connected.
1101	<p>⚠ QUALIFIED PERSON</p> <p>Installation fault > Check connection A second line conductor is connected to N.</p> <p>Corrective measures:</p> <ul style="list-style-type: none"> • Connect the neutral conductor to N.
1302	<p>⚠ QUALIFIED PERSON</p> <p>Waiting for grid voltage > Installation failure grid connection > Check grid and fuses L or N not connected.</p> <p>Corrective measures:</p> <ul style="list-style-type: none"> • Ensure that L and N are connected. • Ensure that the AC cable is not damaged and that it is connected correctly. • Ensure that the circuit breaker is switched on.
1501	<p>⚠ QUALIFIED PERSON</p> <p>Reconnection fault grid The changed country data set or the value of a parameter you have set does not correspond to the local requirements. The inverter cannot connect to the utility grid.</p> <p>Corrective measures:</p> <ul style="list-style-type: none"> • Ensure that the country data set has been configured correctly. To do this, select the parameter Set country standard and check the value.
3302	<p>⚠ QUALIFIED PERSON</p> <p>Unstable operation There is not enough power at the DC input of the inverter for stable operation. The inverter cannot connect to the utility grid.</p> <p>Corrective measures:</p> <ul style="list-style-type: none"> • Ensure that the PV array is designed correctly. • Ensure that the PV array is not covered by snow or otherwise shaded. • Ensure that the PV array is free of errors.

Event number	Message, cause and corrective measures
3303	<p data-bbox="311 183 593 215">⚠ QUALIFIED PERSON</p> <p data-bbox="288 231 490 263">Unstable operation</p> <p data-bbox="288 271 1002 327">There is not enough power at the DC input of the inverter for stable operation. The inverter cannot connect to the utility grid.</p> <p data-bbox="288 335 509 359">Corrective measures:</p> <ul data-bbox="311 367 968 462" style="list-style-type: none"> <li data-bbox="311 367 756 391">• Ensure that the PV array is designed correctly. <li data-bbox="311 399 968 422">• Ensure that the PV array is not covered by snow or otherwise shaded. <li data-bbox="311 430 705 454">• Ensure that the PV array is free of errors.
3401 3402	<p data-bbox="311 478 593 510">⚠ QUALIFIED PERSON</p> <p data-bbox="288 526 694 558">DC overvoltage > Disconnect generator</p> <p data-bbox="288 566 912 622">Overvoltage at the DC input. This can destroy the inverter. This message is signaled additionally by rapid flashing of the LEDs.</p> <p data-bbox="288 630 509 654">Corrective measures:</p> <ul data-bbox="311 662 996 909" style="list-style-type: none"> <li data-bbox="311 662 901 694">• Immediately disconnect the inverter from all voltage sources. <li data-bbox="311 702 996 790">• Check whether the DC voltage is below the maximum input voltage of the inverter. If the DC voltage is below the maximum input voltage of the inverter, reconnect the DC connectors to the inverter. <li data-bbox="311 798 991 877">• If the DC voltage exceeds the maximum input voltage of the inverter, ensure that the PV array has been correctly rated or contact the installer of the PV array. <li data-bbox="311 885 862 909">• If this message is repeated frequently, contact the Service.
3501	<p data-bbox="311 925 593 957">⚠ QUALIFIED PERSON</p> <p data-bbox="288 973 660 1005">Insulation failure > Check generator</p> <p data-bbox="288 1013 800 1037">The inverter has detected a ground fault in the PV array.</p> <p data-bbox="288 1045 509 1069">Corrective measures:</p> <ul data-bbox="311 1077 688 1109" style="list-style-type: none"> <li data-bbox="311 1077 688 1109">• Check the PV system for ground faults.
3601	<p data-bbox="311 1125 593 1157">⚠ QUALIFIED PERSON</p> <p data-bbox="288 1173 694 1204">High discharge curr. > Check generator</p> <p data-bbox="288 1212 946 1268">The leakage current of the inverter and the battery is too high. There is a ground fault, a residual current or a malfunction.</p> <p data-bbox="288 1276 996 1356">The inverter interrupts feed-in operation immediately after exceeding a threshold. When the fault is eliminated, the inverter automatically reconnects to the utility grid.</p> <p data-bbox="288 1364 509 1388">Corrective measures:</p> <ul data-bbox="311 1396 688 1428" style="list-style-type: none"> <li data-bbox="311 1396 688 1428">• Check the PV system for ground faults.

Event number	Message, cause and corrective measures
3701	<p>⚠ QUALIFIED PERSON</p> <p>Resid.curr.too.high > Check generator</p> <p>The inverter has detected a residual current due to temporary grounding of the PV array.</p> <p>Corrective measures:</p> <ul style="list-style-type: none"> • Check the PV system for ground faults.
3801 3802	<p>⚠ QUALIFIED PERSON</p> <p>DC overcurrent > Check generator</p> <p>Overcurrent at the DC input. The inverter briefly interrupts feed-in operation.</p> <p>Corrective measures:</p> <ul style="list-style-type: none"> • If this message is displayed frequently, ensure that the PV array has been correctly rated and wired.
3901 3902	<p>⚠ QUALIFIED PERSON</p> <p>Waiting for DC start conditions > Start cond. not met</p> <p>The feed-in conditions for the utility grid are not yet fulfilled.</p> <p>Corrective measures:</p> <ul style="list-style-type: none"> • Ensure that the PV array is not covered by snow or otherwise shaded. • Wait for higher irradiation. • If this message is displayed frequently in the morning, increase the voltage limit for starting grid feed-in. Change the parameter Critical voltage to start feed-in. • If this message is displayed frequently with medium irradiation, ensure that the PV array is correctly rated.
4011	<p>⚠ QUALIFIED PERSON</p> <p>Bridged strings detected</p> <p>The DC inputs A and B are connected in parallel.</p>
4012	<p>⚠ QUALIFIED PERSON</p> <p>No bridged strings detected</p> <p>The DC inputs A and B are not connected in parallel.</p>
6001-6412	<p>⚠ QUALIFIED PERSON</p> <p>Self diagnosis > Interference device</p> <p>The cause must be determined by the Service.</p> <p>Corrective measures:</p> <ul style="list-style-type: none"> • Contact the service.

Event number	Message, cause and corrective measures
6501 6502 6509	<p>⚠ QUALIFIED PERSON</p> <p>Self-diagnosis > Overtemperature</p> <p>The inverter has switched off due to excessive temperature.</p> <p>Corrective measures:</p> <ul style="list-style-type: none"> • Clean the cooling fins on the rear of the enclosure and the air ducts on the top using a soft brush. • Ensure that the inverter has sufficient ventilation. • Ensure that the ambient temperature +40 °C has not been exceeded. • Ensure that the inverter is not exposed to direct solar irradiation.
6512	<p>Minimum operating temperature not reached</p> <p>The inverter will only recommence grid feed-in once the temperature has reached at least -25 °C.</p>
6603 6604	<p>⚠ QUALIFIED PERSON</p> <p>Self-diagnosis > Overload</p> <p>The cause must be determined by the Service.</p> <p>Corrective measures:</p> <ul style="list-style-type: none"> • Contact the service.
6701 6702	<p>⚠ QUALIFIED PERSON</p> <p>Communication disturbed</p> <p>Error in the communication processor, the inverter continues feeding in, however. The cause must be determined by the Service.</p> <p>Corrective measures:</p> <ul style="list-style-type: none"> • If this message is displayed frequently, contact the Service.
6801 6802	<p>⚠ QUALIFIED PERSON</p> <p>Self-diagnosis > Input A defective</p> <p>Corrective measures:</p> <ul style="list-style-type: none"> • Check whether a string is connected to input A. • Contact the service.
6901 6902	<p>⚠ QUALIFIED PERSON</p> <p>Self-diagnosis > Input B defective</p> <p>Corrective measures:</p> <ul style="list-style-type: none"> • Check whether a string is connected to input B. • Contact the service.

Event number	Message, cause and corrective measures
7001 7002	<p data-bbox="314 188 596 220">⚠ QUALIFIED PERSON</p> <p data-bbox="292 236 415 260">Sensor fault</p> <p data-bbox="292 272 994 325">A temperature sensor in the inverter is defective and the inverter interrupts the feed-in operation. The cause must be determined by the Service.</p> <p data-bbox="292 336 508 360">Corrective measures:</p> <ul data-bbox="311 371 516 395" style="list-style-type: none"> • Contact the service.
7102	<p data-bbox="314 411 596 443">⚠ QUALIFIED PERSON</p> <p data-bbox="292 459 667 483">Parameter file not found or defective</p> <p data-bbox="292 496 967 549">The parameter file was not found or is defective. The update failed. The inverter continues to feed in.</p> <p data-bbox="292 560 508 584">Corrective measures:</p> <ul data-bbox="311 595 804 619" style="list-style-type: none"> • Copy the parameter file to the correct folder again.
7105	<p data-bbox="314 639 596 671">⚠ QUALIFIED PERSON</p> <p data-bbox="292 687 505 711">Param. setting failed</p> <p data-bbox="292 724 994 777">Parameters could not be set using the memory card. The inverter continues to feed in.</p> <p data-bbox="292 788 508 812">Corrective measures:</p> <ul data-bbox="311 823 804 879" style="list-style-type: none"> • Ensure that the parameters are set correctly. • Ensure that the SMA Grid Guard code is available.
7106	<p data-bbox="292 895 479 919">Update file defect.</p> <p data-bbox="292 932 986 984">The update file is defective. The update failed. The inverter continues to feed in.</p>
7110	<p data-bbox="292 1003 505 1027">No update file found</p> <p data-bbox="292 1040 972 1093">No new update file was found on the SD memory card. The update failed. The inverter continues to feed in.</p>
7112	Update file successfully copied
7113	The memory card is full or write-protected
7201	Data storage not possible
7202	Data storage not possible
7303	<p data-bbox="314 1259 596 1291">⚠ QUALIFIED PERSON</p> <p data-bbox="292 1307 538 1331">Update main CPU failed</p> <p data-bbox="292 1343 708 1367">The cause must be determined by the Service.</p> <p data-bbox="292 1378 508 1402">Corrective measures:</p> <ul data-bbox="311 1414 516 1437" style="list-style-type: none"> • Contact the service.

Event number	Message, cause and corrective measures
7320	<p>The device with serial number [xx] was successfully updated to firmware version [xxx].</p> <p>The firmware update was completed successfully.</p>
7330	<p>Condition test failed</p> <p>The testing of the update conditions was successful. The firmware update package is suitable for this inverter.</p>
7331	<p>Update transport started</p> <p>Update file is being copied.</p>
7332	<p>Update transport successful</p> <p>Update file was copied successfully to the inverter's internal memory.</p>
7333	<p>⚠ QUALIFIED PERSON</p> <p>Update transport failed</p> <p>Update file could not be copied to the inverter's internal memory. In the event of connection with the inverter via WLAN, a poor connection quality can be the cause.</p> <p>Corrective measures:</p> <ul style="list-style-type: none"> • Retry update. • For WLAN connection: Improve the WLAN connection quality (e.g. via WLAN repeater) or establish connection with the inverter via Ethernet. • If this message is displayed again, contact the Service.
7341	<p>Update Bootloader</p> <p>The inverter is performing a bootloader update.</p>
7342	<p>⚠ QUALIFIED PERSON</p> <p>Update Bootloader failed</p> <p>The bootloader update failed.</p> <p>Corrective measures:</p> <ul style="list-style-type: none"> • Retry update. • If this message is displayed again, contact the Service.
7347	<p>⚠ QUALIFIED PERSON</p> <p>Incompatible file</p> <p>The configuration file is not suitable for this inverter.</p> <p>Corrective measures:</p> <ul style="list-style-type: none"> • Ensure that the selected configuration file is suitable for this inverter. • Retry import.

Event number	Message, cause and corrective measures
7348	<p data-bbox="314 188 596 220">⚠ QUALIFIED PERSON</p> <p data-bbox="292 236 493 263">Incorrect file format</p> <p data-bbox="292 272 885 300">The configuration file is not of the required format or is damaged.</p> <p data-bbox="292 309 508 336">Corrective measures:</p> <ul data-bbox="311 341 999 432" style="list-style-type: none"> <li data-bbox="311 341 999 395">• Ensure that the selected configuration file is of the required format and is not damaged. <li data-bbox="311 405 452 432">• Retry import.
7349	<p data-bbox="292 443 717 470">Incorrect login rights for configuration file</p> <p data-bbox="292 480 986 534">The user group logged in does not have the user rights necessary to be able to import a configuration.</p> <p data-bbox="292 544 508 571">Corrective measures:</p> <ul data-bbox="311 580 617 643" style="list-style-type: none"> <li data-bbox="311 580 508 608">• Log in as Installer. <li data-bbox="311 617 617 643">• Import configuration file again.
7350	<p data-bbox="292 654 721 681">Transfer of a configuration file has started</p> <p data-bbox="292 691 669 716">The configuration file is being transferred.</p>
7351	<p data-bbox="292 727 445 754">Update WLAN</p> <p data-bbox="292 764 687 790">The inverter is updating the WLAN module.</p>
7352	<p data-bbox="292 801 617 828">Update of WLAN not successful</p> <p data-bbox="292 837 658 865">The update of the WLAN module failed.</p> <p data-bbox="292 874 508 901">Corrective measures:</p> <ul data-bbox="311 911 833 970" style="list-style-type: none"> <li data-bbox="311 911 460 938">• Retry update. <li data-bbox="311 948 833 970">• If this message is displayed again, contact the Service.
7353	<p data-bbox="292 981 580 1008">Update time zone database</p> <p data-bbox="292 1021 732 1043">The inverter is updating the time zone database.</p>
7354	<p data-bbox="314 1058 596 1090">⚠ QUALIFIED PERSON</p> <p data-bbox="292 1114 751 1141">Update of time zone database not successful</p> <p data-bbox="292 1150 703 1177">The update of the time zone database failed.</p> <p data-bbox="292 1187 508 1214">Corrective measures:</p> <ul data-bbox="311 1224 833 1281" style="list-style-type: none"> <li data-bbox="311 1224 460 1251">• Retry update. <li data-bbox="311 1260 833 1281">• If this message is displayed again, contact the Service.
7355	<p data-bbox="292 1292 449 1319">Update WebUI</p> <p data-bbox="292 1329 743 1355">The inverter is updating the inverter user interface.</p>

Event number	Message, cause and corrective measures
7356	<p>⚠ QUALIFIED PERSON</p> <p>Update of the WebUI not successful The update of the inverter user interface failed.</p> <p>Corrective measures:</p> <ul style="list-style-type: none"> • Retry update. • If this message is displayed again, contact the Service.
7500 7501	<p>⚠ QUALIFIED PERSON</p> <p>Fan fault > Check inverter electronic and fan</p> <p>Corrective measures:</p> <ul style="list-style-type: none"> • Contact the service.
7619	<p>⚠ QUALIFIED PERSON</p> <p>Communication fault with meter unit > Check communication to meter The inverter is not receiving any data from the energy meter.</p> <p>Corrective measures:</p> <ul style="list-style-type: none"> • Ensure that the energy meter is correctly integrated into the same network as the inverter (see energy meter manual). • For WLAN connection: Improve the WLAN connection quality (e.g. via WLAN repeater) or connect the inverter with the DHCP server (router) via Ethernet.
7701 7702 7703	<p>⚠ QUALIFIED PERSON</p> <p>Interference device The cause must be determined by the Service.</p> <p>Corrective measures:</p> <ul style="list-style-type: none"> • Contact the service.
8003	<p>⚠ QUALIFIED PERSON</p> <p>Active power limited Temperature The inverter has reduced its power output for more than ten minutes due to excessive temperature.</p> <p>Corrective measures:</p> <ul style="list-style-type: none"> • Clean the cooling fins on the rear of the enclosure and the air ducts on the top using a soft brush. • Ensure that the inverter has sufficient ventilation. • Ensure that the ambient temperature does not exceed +40 °. • Ensure that the inverter is not exposed to direct solar irradiation.

Event number	Message, cause and corrective measures
8101	⚠ QUALIFIED PERSON
8102	Communication disturbed
8103	The cause must be determined by the Service.
8104	Corrective measures:
	<ul style="list-style-type: none"> • Contact the service.
8708	<p>Timeout in communication for active power limitation</p> <p>Communication to the system control absent. Depending on the fall-back setting, either the last received values will be retained or the active power will be limited to the set percentage value of the inverter nominal power.</p> <p>Corrective measures:</p> <ul style="list-style-type: none"> • Ensure that the connection to the system manager (e.g. Sunny Home Manager) is intact and that no cables are damaged or that no plugs have been pulled.
8709	<p>Timeout in communication for reactive power spec.</p> <p>Communication to the system control absent. Depending on the fall-back setting, either the last received values will be retained or the reactive power will be set to the set value.</p> <p>Corrective measures:</p> <ul style="list-style-type: none"> • Ensure that the connection to the system manager (e.g. Sunny Home Manager) is intact and that no cables are damaged or that no plugs have been pulled.
8710	<p>Timeout in communication for cos-Phi spec.</p> <p>Communication to the system control absent. Depending on the fall-back setting, either the last received values will be retained or the displacement power factor will be set to the set value.</p> <p>Corrective measures:</p> <ul style="list-style-type: none"> • Ensure that the connection to the system manager (e.g. Sunny Home Manager) is intact and that no cables are damaged or that no plugs have been pulled.
9002	<p>⚠ QUALIFIED PERSON</p> <p>SMA Grid Guard code invalid</p> <p>The SMA Grid Guard code entered is incorrect. The operating parameters are still protected and cannot be changed.</p> <p>Corrective measures:</p> <ul style="list-style-type: none"> • Enter the correct SMA Grid Guard code.

Event number	Message, cause and corrective measures
9003	<p>Grid parameter locked</p> <p>Changes to the grid parameters are now blocked. In order to be able to make changes to the grid parameters, from now on you must log in using the SMA Grid Guard code.</p>
9005	<p>⚠ QUALIFIED PERSON</p> <p>Changing of grid parameters not possible > Ensure DC supply</p> <p>This error can have the following causes:</p> <ul style="list-style-type: none"> • The parameters to be changed are protected. • The DC voltage at the DC input is not sufficient to run the main CPU. <p>Corrective measures:</p> <ul style="list-style-type: none"> • Enter the SMA Grid Guard code. • Ensure that at least the DC start voltage is available (green LED is flashing, pulsing or glowing).
9007	<p>⚠ QUALIFIED PERSON</p> <p>Abort self-test</p> <p>The self-test (Italy only) was terminated.</p> <p>Corrective measures:</p> <ul style="list-style-type: none"> • Ensure that the AC connection is correct. • Restart the self-test.
10108	<p>Time adjusted / old time</p>
10109	<p>Time adjusted / new time</p>
10110	<p>⚠ QUALIFIED PERSON</p> <p>Time synchronization failed: tn0 </p> <p>No time information could be called up from the set NTP server.</p> <p>Corrective measures:</p> <ul style="list-style-type: none"> • Ensure that the NTP server was configured correctly. • Ensure that the inverter is integrated into a local network with Internet connection.
10118	<p>Parameter upload complete</p> <p>The configuration file was loaded successfully.</p>

Event number	Message, cause and corrective measures
10248	<p data-bbox="311 188 595 220">⚠ QUALIFIED PERSON</p> <p data-bbox="288 236 553 263">[Interface]: network busy</p> <p data-bbox="288 272 1012 327">The network is busy. Data exchange between the devices is not at an optimum and is greatly delayed.</p> <p data-bbox="288 336 508 363">Corrective measures:</p> <ul data-bbox="311 371 866 427" style="list-style-type: none"> <li data-bbox="311 371 591 399">• Increase the query intervals. <li data-bbox="311 403 866 427">• If necessary, reduce the number of devices in the network.
10249	<p data-bbox="311 451 595 483">⚠ QUALIFIED PERSON</p> <p data-bbox="288 499 622 526">[Interface]: network overloaded</p> <p data-bbox="288 536 990 563">The network is overloaded. There is no data exchange between the devices.</p> <p data-bbox="288 572 508 600">Corrective measures:</p> <ul data-bbox="311 608 759 663" style="list-style-type: none"> <li data-bbox="311 608 759 635">• Reduce the number of devices in the network. <li data-bbox="311 639 759 663">• If necessary, increase the data query intervals.
10250	<p data-bbox="311 679 595 711">⚠ QUALIFIED PERSON</p> <p data-bbox="288 727 723 754">[Interface]: package error rate [ok / high]</p> <p data-bbox="288 764 1012 847">The package error rate has changed. If the package error rate is high, the network is overloaded or the connection to the network switch or DHCP server (router) is disturbed.</p> <p data-bbox="288 857 837 884">Corrective measures if the package error rate is high:</p> <ul data-bbox="311 892 1012 1043" style="list-style-type: none"> <li data-bbox="311 892 1012 975">• Ensure that with an Ethernet connection, the network cable and the network connector are not damaged and that the network connectors are correctly plugged. <li data-bbox="311 979 759 1007">• If necessary, increase the data query intervals. <li data-bbox="311 1011 866 1043">• If necessary, reduce the number of devices in the network.
10251	<p data-bbox="288 1062 967 1114">[Interface]: communication status goes to [OK / Warning / Error / Not connected]</p> <p data-bbox="288 1123 990 1177">The communication status to the network switch or DHCP server (router) has changed. An additional error message may be displayed.</p>

Event number	Message, cause and corrective measures
10252	<p data-bbox="311 188 594 220">⚠ QUALIFIED PERSON</p> <p data-bbox="288 236 672 268">[Interface]: communication disrupted</p> <p data-bbox="288 272 687 300">There is no valid signal on the network line.</p> <p data-bbox="288 308 508 335">Corrective measures:</p> <ul data-bbox="311 341 1012 491" style="list-style-type: none"> <li data-bbox="311 341 1012 427">• Ensure that with an Ethernet connection, the network cable and the network connector are not damaged and that the network connectors are correctly plugged. <li data-bbox="311 432 1012 491">• Ensure that the DHCP server (router) and any network switches are signaling correct operation.
10253	<p data-bbox="311 502 594 534">⚠ QUALIFIED PERSON</p> <p data-bbox="288 550 891 582">[Interface]: connection speed goes to [100 Mbit / 10 Mbit]</p> <p data-bbox="288 587 1003 673">The data transfer rate has changed. The cause for the status [10 Mbit] can be a defective plug, a defective cable or the pulling or plugging of the network connector.</p> <p data-bbox="288 679 752 707">Corrective measures if the status is [10 Mbit]:</p> <ul data-bbox="311 713 1012 863" style="list-style-type: none"> <li data-bbox="311 713 1012 799">• Ensure that with an Ethernet connection, the network cable and the network connector are not damaged and that the network connectors are correctly plugged. <li data-bbox="311 804 1012 863">• Ensure that the DHCP server (router) and any network switches are signaling correct operation.
10254	<p data-bbox="311 879 594 911">⚠ QUALIFIED PERSON</p> <p data-bbox="288 927 752 959">[Interface]: duplex mode goes to [Full / Half]</p> <p data-bbox="288 963 1003 1050">The duplex mode (data transfer mode) has changed. The cause for the status [Half] can be a defective plug, a defective cable or the pulling or plugging of the network connector.</p> <p data-bbox="288 1056 716 1083">Corrective measures if the status is [Half]:</p> <ul data-bbox="311 1090 1012 1240" style="list-style-type: none"> <li data-bbox="311 1090 1012 1176">• Ensure that with an Ethernet connection, the network cable and the network connector are not damaged and that the network connectors are correctly plugged. <li data-bbox="311 1181 1012 1240">• Ensure that the DHCP server (router) and any network switches are signaling correct operation.
10255	<p data-bbox="311 1256 594 1287">⚠ QUALIFIED PERSON</p> <p data-bbox="288 1303 596 1335">[Interface]: Network load OK</p> <p data-bbox="288 1340 900 1367">The network load has returned to a normal range after being busy.</p>

Event number	Message, cause and corrective measures
10282	<p>[User group]-Login via [protocol] locked</p> <p>After several incorrect login attempts, login has been blocked for a limited time. In this case, the User login will be blocked for 15 minutes, the Grid Guard login for 12 hours.</p> <p>Corrective measures:</p> <ul style="list-style-type: none"> • Wait until the given time has expired and then retry login.
10283	<p>⚠ QUALIFIED PERSON</p> <p>WLAN module faulty</p> <p>The WLAN module integrated in the inverter is defective.</p> <p>Corrective measures:</p> <ul style="list-style-type: none"> • Contact the service.
10284	<p>⚠ QUALIFIED PERSON</p> <p>No WLAN connection possible</p> <p>The inverter does not currently have a WLAN connection to the selected network.</p> <p>Corrective measures:</p> <ul style="list-style-type: none"> • Ensure that the SSID, the WLAN password and the encryption method have been entered correctly. The encryption method is specified by your WLAN router or WLAN Access Point and can be changed there. • Ensure that the WLAN router or WLAN Access Point is in range and is signaling correct operation. • If this message is displayed often, improve the WLAN connection by using a WLAN repeater.
10285	<p>WLAN connection established</p> <p>Connection to the selected WLAN network has been established.</p>
10286	<p>⚠ QUALIFIED PERSON</p> <p>WLAN connection lost</p> <p>The inverter has lost WLAN connection to the selected network.</p> <p>Corrective measures:</p> <ul style="list-style-type: none"> • Ensure that the WLAN router or WLAN Access Point is still active. • Ensure that the WLAN router or WLAN Access Point is in range and is signaling correct operation. • If this message is displayed often, improve the WLAN connection by using a WLAN repeater.
10339	<p>Webconnect enabled</p> <p>The Webconnect function has been enabled.</p>

Event number	Message, cause and corrective measures
10340	<p>Webconnect disabled</p> <p>The Webconnect function has been disabled.</p>
10502	<p>Active power limited AC frequency</p> <p>The inverter has reduced its power due to a too-high power frequency to ensure grid stability.</p> <p>Corrective measures:</p> <ul style="list-style-type: none"> • If possible, check the power frequency and observe how often fluctuations occur. If fluctuations occur frequently and this message is displayed often, contact the grid operator and request approval to change the operating parameters of the inverter. If the grid operator gives his approval, discuss any changes to the operating parameters with the Service.
10901	<p>Start self-test [xx]</p> <p>The self-test is running.</p>
10902	<p>Uac RPro [xxx] V</p> <p>Preliminary result of the self-test</p>
10903	<p>Uac Max [xxx] V</p> <p>Preliminary result of the self-test</p>
10904	<p>Uac Min [xxx] V</p> <p>Preliminary result of the self-test</p>
10905	<p>Uac Min Fast [xxx] V</p> <p>Preliminary result of the self-test</p>
10906	<p>Fac SwMax [xxx] Hz</p> <p>Preliminary result of the self-test</p>
10907	<p>Fac SwMin [xxx] Hz</p> <p>Preliminary result of the self-test</p>
10908	<p>Fac Max [xxx] Hz</p> <p>Preliminary result of the self-test</p>
10909	<p>Fac Min [xxx] Hz</p> <p>Preliminary result of the self-test</p>
10910	<p>Disconn. threshold [xxx] [xx]</p> <p>Preliminary result of the self-test</p>
10911	<p>Stand. Val. [xxx] [xx]</p> <p>Preliminary result of the self-test</p>
10912	<p>Disconn. time [xx] s</p> <p>Preliminary result of the self-test</p>

Event number	Message, cause and corrective measures
27103	Set parameter The parameter changes are being adopted.
27104	Parameters set successfully The parameter changes were successfully adopted.
27107	Update file OK The update file found is valid.
27301	Update communication The inverter is updating the communication component.
27302	Update main CPU The inverter is updating the inverter component.
27312	Update completed The inverter has successfully completed the update.
29001	Inst. code valid The entered Grid Guard code is valid. Protected parameters have now been unlocked and you can adjust the parameters. The parameters will be automatically locked again after ten feed-in hours.
29004	Grid parameters unchanged Changing the grid parameters is not possible.

11.3 Checking the PV System for Ground Faults

A ground fault may be present if the inverter beeps, the red LED lights up and the event numbers 3501, 3601 or 3701 are being displayed in the **Results** menu on the inverter user interface. The electrical insulation from the PV system to ground is defective or insufficient.

DANGER

Danger to life due to electric shock when touching live system components in case of a ground fault

If a ground fault occurs, parts of the system may still be live. Touching live parts and cables results in death or lethal injuries due to electric shock.

- Disconnect the product from voltage sources and make sure it cannot be reconnected before working on the device.
- Touch the cables of the PV array on the insulation only.
- Do not touch any parts of the substructure or frame of the PV array.
- Do not connect PV strings with ground faults to the inverter.

⚠ WARNING**Danger to life due to electric shock from destruction of the measuring device due to overvoltage**

Overvoltage can damage a measuring device and result in voltage being present in the enclosure of the measuring device. Touching the live enclosure of the measuring device results in death or lethal injuries due to electric shock.

- Only use measuring devices with a DC input voltage range of 600 V or higher.

Procedure:

In order to check the PV system for ground faults, perform the following actions in the prescribed order. The exact procedure is described in the following sections.

- Check the PV system for ground faults by measuring the voltage.
- If the voltage measurement was not successful, check the PV system via insulation resistance measurement for ground faults.

Test by Measuring the Voltage

Proceed as follows to check each string in the PV system for ground faults.

Procedure:

1.

⚠ DANGER**Danger to life due to high voltages**

- Disconnect the inverter from all voltage sources (see Section 9, page 69).

2. Measure the voltages:

- Measure the voltage between the positive terminal and the ground potential (PE).
- Measure the voltage between the negative terminal and the ground potential (PE).
- Measure the voltage between the positive and negative terminals.

If the following results are present at the same time, there is a ground fault in the PV system:

- All measured voltages are stable.
- The sum of the two voltages to ground potential is approximately equal to the voltage between the positive and negative terminals.

3. If a ground fault is present, determine the location of the ground fault via the ratio of the two measured voltages and eliminate the ground fault.
4. If a definite ground fault cannot be measured and the message is still displayed, measure the insulation resistance.
5. Reconnect the strings without ground faults to the inverter and recommission the inverter (see inverter installation inverter).

Location of the ground fault

The example shows a ground fault between the second and third PV module.

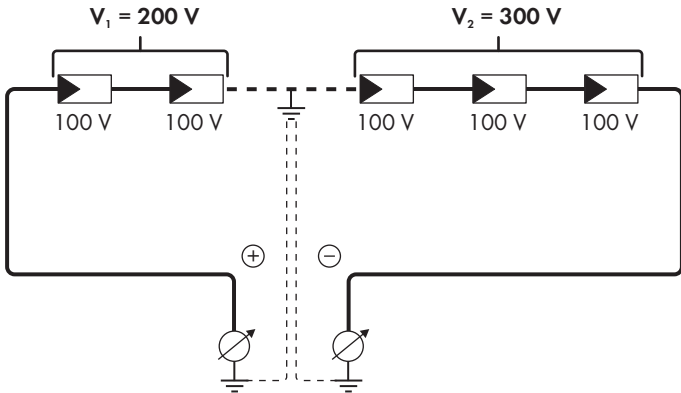

Test by Measuring the Insulation Resistance

If the voltage measurement does not provide sufficient evidence of a ground fault, the insulation resistance measurement can provide more exact results.

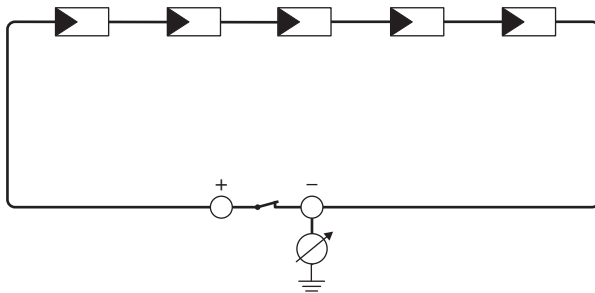

Figure 15: Schematic diagram of the measurement

Calculating the insulation resistance

The expected total resistance of the PV system or of an individual string can be calculated using the following formula:

$$R_{\text{total}}$$

The exact insulation resistance of a PV module can be obtained from the module manufacturer or the datasheet.

For the resistance of a PV module an average value can be assumed: for thin-film PV modules approximately 40 MΩ and for polycrystalline and monocrystalline PV modules approximately 50 MΩ per PV module (for further information on calculating the insulation resistance see the Technical Information "Insulation Resistance (Riso) of Non-Galvanically Isolated PV Systems" at www.SMA-Solar.com).

Required devices:

- Suitable device for safe disconnection and short-circuiting
- Measuring device for insulation resistance

Device required for safe disconnection and short-circuiting of the PV array

The insulation resistance can only be measured with a suitable device for safe disconnection and short-circuiting of the PV array. If no suitable device is available, the insulation measurement must not be carried out.

Procedure:

1. Calculate the expected insulation resistance per string.

- 2.

 **DANGER**

Danger to life due to high voltages

- Disconnect the inverter from all voltage sources (see Section 9, page 69).

3. Install the short circuit device.
4. Connect the measuring device for insulation resistance.
5. Short-circuit the first string.
6. Set the test voltage. The test voltage should be as close as possible to the maximum system voltage of the PV modules but must not exceed it (see datasheet of the PV modules).
7. Measure the insulation resistance.
8. Eliminate the short circuit.
9. Measure the remaining strings in the same manner.
 - If the insulation resistance of a string deviates considerably from the theoretically calculated value, there is a ground fault present in that string.
10. Reconnect to the inverter only those strings from which the ground fault has been eliminated.
11. Reconnect all other strings to the inverter.

12. Recommission the inverter.
13. If the inverter still displays an insulation error, contact the Service (see Section 14, page 106).
The PV modules might not be suitable for the inverter in the present quantity.

11.4 Problems with streaming services

If you use the streaming service in your local network (in which the inverter is also included), there may be interference to the transfer of data. In this case, the IGMP settings of the inverter can be changed via operating parameters.

- Contact the Service and change IGMP settings in consultation with the Service department.

12 Decommissioning the Inverter

To decommission the inverter completely upon completion of its service life, proceed as described in this Section.

⚠ CAUTION

Risk of injury due to weight of product

Injuries may result if the product is lifted incorrectly or dropped while being transported or mounted.

- Transport and lift the product carefully. Take the weight of the product into account.
- Wear suitable personal protective equipment for all work on the product.

Procedure:

1.

⚠ DANGER

Danger to life due to high voltages

- Disconnect the inverter from all voltage sources (see Section 9, page 69).

2.

⚠ CAUTION

Risk of burns due to hot enclosure parts

- Wait 30 minutes for the enclosure to cool down.

3. Unscrew the RS485 plug and pull it out of the jack.

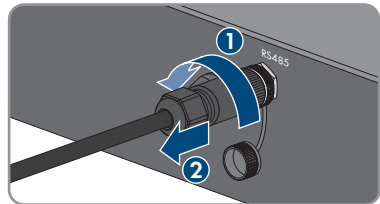

4. Screw the protective cap onto the RS485 jack.

5. Unscrew the swivel nut from the threaded sleeve for the network cable.

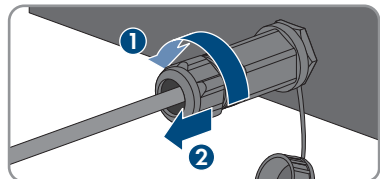

6. Unscrew and remove the threaded sleeve from the network port thread on the inverter.

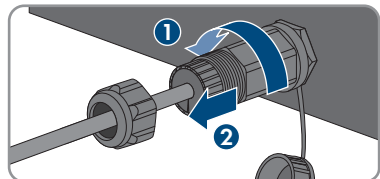

7. Release the network cable plug and pull it out of the jack on the inverter.

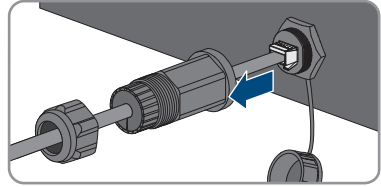

8. Take the cable support sleeve out of the threaded sleeve and remove the network cable from the cable support sleeve.

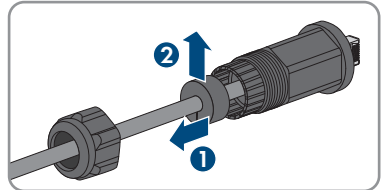

9. Lead the network cable out of the threaded sleeve and the swivel nut.

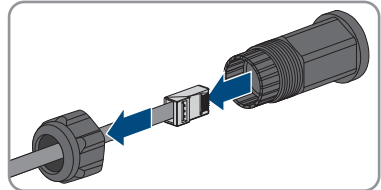

10. Screw the protective cap onto the network port.

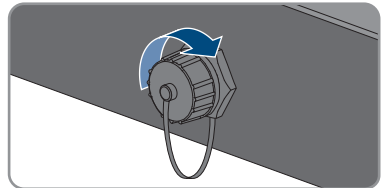

11. Unscrew and remove the antenna.

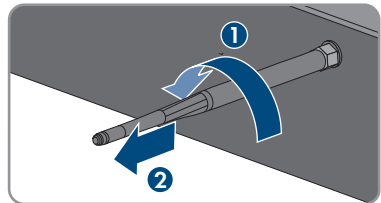

12. If there is a protective cap available, plug the protective cap onto the jack for connecting the antenna.

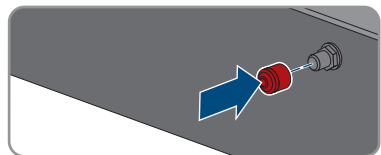

13. If an additional grounding or an equipotential bonding is connected to the inverter, unscrew the pan head screw M5x12 (TX25) and remove the grounding cable.

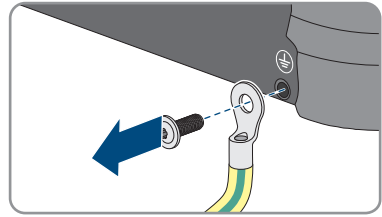

14. Unscrew the left- and right-hand pan head screws M5x12 used to secure the inverter to the wall mounting bracket (TX25).

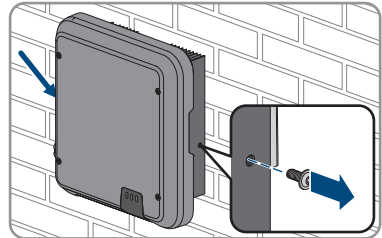

15. Remove the inverter by lifting it vertically up and off the wall mounting bracket.

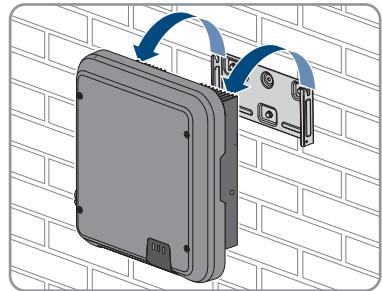

16. Unscrew the screws for fastening the wall mounting bracket and remove the wall mounting bracket.

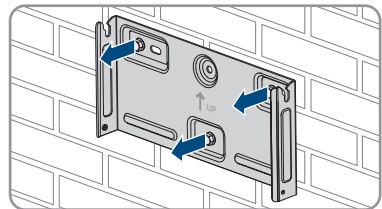

17. If the inverter is to be stored or shipped, pack the inverter, the AC connector, the DC connector, the RJ45 protective sleeve, the antenna and the wall mounting bracket. Use the original packaging or packaging that is suitable for the weight and dimensions of the inverter.
18. Dispose of the inverter in accordance with the locally applicable disposal regulations for electronic waste.

13 Technical Data

13.1 DC/AC

13.1.1 Sunny Boy 3.0 / 3.6 / 4.0

DC input

	SB3.0-1AV-41	SB3.6-1AV-41	SB4.0-1AV-41
Maximum power of PV array	5500 Wp	5500 Wp	7500 Wp
Maximum input voltage	600 V	600 V	600 V
MPP voltage range	125 V to 500 V	125 V to 500 V	125 V to 500 V
Rated input voltage	365 V	365 V	365 V
Minimum input voltage	100 V	100 V	100 V
Initial input voltage	125 V	125 V	125 V
Maximum input current, input A	15 A	15 A	15 A
Maximum input current, input B	15 A	15 A	15 A
Maximum input current per string, input A	15 A	15 A	15 A
Maximum input current per string, input B	15 A	15 A	15 A
Maximum short-circuit current, input A*	20 A	20 A	20 A
Maximum short-circuit current, input B*	20 A	20 A	20 A
Maximum reverse current into the PV modules	0 A	0 A	0 A
Number of independent MPP inputs	2	2	2
Strings per MPP input	2	2	2
Surge category in accordance with IEC 60664-1	II	II	II

* In accordance with IEC 62109-2: ISC PV

AC Output

	SB3.0-1AV-41	SB3.6-1AV-41	SB4.0-1AV-41
Rated power at 230 V, 50 Hz	3000 W	3680 W	4000 W
Maximum apparent AC power at $\cos \varphi = 1$	3000 VA	3680 VA	4000 VA
Rated grid voltage	230 V	230 V	230 V
Nominal AC voltage	220 V / 230 V / 240 V	220 V / 230 V / 240 V	220 V / 230 V / 240 V
AC voltage range*	180 V to 280 V	180 V to 280 V	180 V to 280 V
Nominal AC current at 220 V	13.7 A	16 A	18.2 A
Nominal AC current at 230 V	13.1 A	16 A	17.4 A
Nominal AC current at 240 V	12.5 A	15.4 A	16.7 A
Maximum output current	13.7 A	16 A	18.2 A
Total harmonic distortion of the output current with total harmonic distortion of the AC voltage <2%, and AC power >50% of the rated power	≤3 %	≤3 %	≤3 %
Maximum output current under fault conditions	29 A	29 A	29 A
Inrush current	< 20% of the nominal AC current for a maximum of 10 ms	< 20% of the nominal AC current for a maximum of 10 ms	< 20% of the nominal AC current for a maximum of 10 ms
Rated grid frequency	50 Hz	50 Hz	50 Hz
AC grid frequency*	50 Hz / 60 Hz	50 Hz / 60 Hz	50 Hz / 60 Hz
Operating range at AC grid frequency 50 Hz	45 Hz to 55 Hz	45 Hz to 55 Hz	45 Hz to 55 Hz
Operating range at AC grid frequency 60 Hz	55 Hz to 65 Hz	55 Hz to 65 Hz	55 Hz to 65 Hz

	SB3.0-1AV-41	SB3.6-1AV-41	SB4.0-1AV-41
Power factor at rated power	1	1	1
Displacement power factor $\cos \varphi$, adjustable	0.8 overexcited to 0.8 underexcited	0.8 overexcited to 0.8 underexcited	0.8 overexcited to 1 to 0.8 underexcited
Feed-in phases	1	1	1
Connection phases	1	1	1
Surge category in accordance with IEC 60664-1	III	III	III

* Depending on the configured country data set

Efficiency

	SB3.0-1AV-41	SB3.6-1AV-41	SB4.0-1AV-41
Maximum efficiency, η_{\max}	97.0 %	97.0 %	97.0 %
European weighted efficiency, η_{EU}	96.4 %	96.5 %	96.5 %

13.1.2 Sunny Boy 5.0 / 6.0

DC input

	SB5.0-1AV-41	SB6.0-1AV-41
Maximum power of PV array	7500 W _p	9000 W _p
Maximum input voltage	600 V	600 V
MPP voltage range	125 V to 500 V	125 V to 500 V
Rated input voltage	365 V	365 V
Minimum input voltage	100 V	100 V
Initial input voltage	125 V	125 V
Maximum input current, input A	15 A	15 A
Maximum input current, input B	15 A	15 A
Maximum input current per string, input A	15 A	15 A
Maximum input current per string, input B	15 A	15 A
Maximum short-circuit current, input A*	20 A	20 A

	SB5.0-1AV-41	SB6.0-1AV-41
Maximum short-circuit current, input B*	20 A	20 A
Maximum reverse current into the PV modules	0 A	0 A
Number of independent MPP inputs	2	2
Strings per MPP input	2	2
Surge category in accordance with IEC 60664-1	II	II

* In accordance with IEC 62109-2: ISC PV

AC Output

	SB5.0-1AV-41	SB6.0-1AV-41
Rated power at 230 V, 50 Hz*	5000 W	6000 W
Maximum apparent AC power at $\cos \varphi = 1$ **	5000 VA	6000 VA
Rated grid voltage	230 V	230 V
Nominal AC voltage	220 V / 230 V / 240 V	220 V / 230 V / 240 V
AC voltage range***	180 V to 280 V	180 V to 280 V
Nominal AC current at 220 V	22.8 A	26.1 A
Nominal AC current at 230 V	22 A	26.1 A
Nominal AC current at 240 V	21 A	25 A
Maximum output current****	22.8 A	26.1 A
Total harmonic distortion of the output current with total harmonic distortion of the AC voltage <2%, and AC power >50% of the rated power	≤3 %	≤3 %
Maximum output current under fault conditions	29 A	29 A
Inrush current	< 20% of the nominal AC current for a maximum of 10 ms	< 20% of the nominal AC current for a maximum of 10 ms
Rated grid frequency	50 Hz	50 Hz
AC grid frequency***	50 Hz / 60 Hz	50 Hz / 60 Hz
Operating range at AC grid frequency 50 Hz	45 Hz to 55 Hz	45 Hz to 55 Hz
Operating range at AC grid frequency 60 Hz	55 Hz to 65 Hz	55 Hz to 65 Hz
Power factor at rated power	1	1

	SB5.0-1AV-41	SB6.0-1AV-41
Displacement power factor $\cos \varphi$, adjustable	0.8 overexcited to 1 to 0.8 underexcited	0.8 overexcited to 0.8 underexcited
Feed-in phases	1	1
Connection phases	1	1
Surge category in accordance with IEC 60664-1	III	III

* According to VDE-AR-N 4105, the rated power at 230 V, 50 Hz of the SB5.0-1AV-41 is 4600 W

** According to VDE-AR-N 4105, the rated power at 230 V, 50 Hz of the SB5.0-1AV-41 is 4600 VA

*** Depending on the configured country data set

**** According to AS 4777, the maximum output current is 21.7 A

Efficiency

	SB5.0-1AV-41	SB6.0-1AV-41
Maximum efficiency, η_{\max}	97.0 %	97.0 %
European weighted efficiency, η_{EU}	96.5 %	96.5 %

13.2 General Data

Width x height x depth	435 mm x 470 mm x 176 mm
Weight	16 kg
Length x width x height of the packaging	495 mm x 595 mm x 250 mm
Transport weight	20.5 kg
Climatic category in accordance with IEC 60721-3-4	4K4H
Environmental category	outdoors
Pollution degree outside the enclosure	3
Pollution degree inside the enclosure	2
Operating temperature range	-25 °C to +60 °C
Max. permissible value for relative humidity (condensing)	100 %
Maximum operating altitude above mean sea level (MSL)	3000 m
Typical noise emission	25 dB(A)
Power loss in night mode	5 W
Maximum data volume per inverter with Speed-wire/Webconnect	550 MB/month

Additional data volume when using the Sunny Portal live interface	660 kB/hour
Power control / Demand response (DRED)	Communication via Modbus interface
Demand Response Mode	DRM0
Topology	Transformerless (Non-isolated)
Cooling method	Convection
Degree of protection for electronics in accordance with IEC 60529	IP65
Protection class in accordance with IEC 62109-1	I
Radio technology	WLAN 802.11 b/g/n
Radio spectrum	2.4 GHz
Maximum transmission power	100 mW
Quantity maximum detectable Wi-Fi networks	32
Grid configurations*	IT, Delta-IT, TN-C, TN-S, TN-C-S, TT (when $V_{N_PE} < 20\text{ V}$)

* **IT, Delta-IT:** When using in these systems, the grounding conductor monitoring must be deactivated and an additional grounding connected to the inverter.

13.3 Climatic Conditions

Installation in accordance with IEC 60721-3-3, Class 4K4H

Extended temperature range	-25 °C to +60 °C
Extended humidity range	0% to 100%
Extended air pressure range	79.5 kPa to 106 kPa

Transport in accordance with IEC 60721-3-2, Class 2K3

Temperature range	-25 °C to +70 °C
-------------------	------------------

13.4 Protective Devices

DC reverse polarity protection	Short-circuit diode
Input-side disconnection point	DC load-break switch
AC short-circuit current capability	Current control
Grid monitoring	SMA Grid Guard 10.0
Maximal output overcurrent protection	32 A
Ground fault monitoring	Insulation monitoring: $R_{iso} > 200\text{ k}\Omega$

All-pole sensitive residual-current monitoring unit	Available
Active anti-islanding method	Frequency shift

13.5 Equipment

DC connection	SUNCLIX DC connector
AC connection	AC connector
WLAN	As standard
SMA Speedwire/Webconnect	As standard
RS485	As standard

13.6 Torques

Screws for securing the inverter to the wall mounting bracket	2.5 Nm
Additional grounding	2.5 Nm
SUNCLIX swivel nut	2.0 Nm
Screw terminals of the AC connector	1.5 Nm ± 0.3 Nm

13.7 Data Storage Capacity

Energy yields in the course of the day	63 days
Daily yields	30 years
Event messages for users	1024 events
Event messages for installers	1024 events

14 Contact

If you have technical problems with our products, please contact the SMA Service Line. The following data is required in order to provide you with the necessary assistance:

- Device type
- Serial number
- Firmware version
- Event message
- Mounting location and mounting height
- Type and number of PV modules
- Optional equipment, e.g. communication products
- Use the name of the system in Sunny Portal (if available)
- Access data for Sunny Portal (if available)
- Special country-specific settings (if available)

You can find your country's contact information at:



<https://go.sma.de/service>

15 EU Declaration of Conformity

within the scope of the EU directives

- Radio Equipment Directive 2014/53/EU (22.5.2014 L 153/62) (RED)
- Restriction of the use of certain hazardous substances 2011/65/EU (L 174/88, June 8, 2011) and 2015/863/EU (L 137/10, March 31, 2015) (RoHS)



SMA Solar Technology AG confirms herewith that the products described in this document are in compliance with the fundamental requirements and other relevant provisions of the above-mentioned directives. The entire EU Declaration of Conformity can be found at www.SMA-Solar.com.



www.SMA-Solar.com

